



# Installation Operation Maintenance

**CGWH Packaged Water-cooled liquid chiller**

**CCUH Condenserless liquid chiller**

Sizes 115 - 120 - 125 - 225 - 230 - 235 - 240 - 250



To be used with the user guide of CH530 scroll chiller controls

**CGWH-SVX01E-GB**

# General information

---

## Foreword

These instructions are given as a guide to good practice in the installation, start-up, operation, and maintenance by the user, of Trane CGWH/CCUH chillers. They do not contain full service procedures necessary for the continued successful operation of this equipment. The services of a qualified technician should be employed through the medium of a maintenance contract with a reputable service company. Read this manual thoroughly before unit start-up.

Units are assembled, pressure tested, dehydrated, charged and run tested before shipment.

## Warnings and cautions

Warnings and Cautions appear at appropriate sections throughout this manual. Your personal safety and the proper operation of this machine require that you follow them carefully. The constructor assumes no liability for installations or servicing performed by unqualified personnel.

**WARNING!** : Indicates a potentially hazardous situation which, if not avoided, could result in death or serious injury.

**CAUTION!** : Indicates a potentially hazardous situation which, if not avoided, may result in minor or moderate injury. It may also be used to alert against unsafe practices or for equipment or property-damage-only accidents.

## Safety recommendations

To avoid death, injury, equipment or property damage, the following recommendations should be observed during maintenance and service visits:

1. The maximum allowable pressures for system leak testing on low and high pressure side are given in the chapter "Installation". Always provide a pressure regulator.
2. Disconnect the main power supply before any servicing on the unit.
3. Service work on the refrigeration system and the electrical system should be carried out only by qualified and experienced personnel.

## Reception

On arrival, inspect the unit before signing the delivery note.

### Reception in France only:

In case of visible damage: The consignee (or the site representative) must specify any damage on the delivery note, legibly sign and date the delivery note, and the truck driver must countersign it. The consignee (or the site representative) must notify Trane Epinal Operations - Claims team and send a copy of the delivery note. The customer (or the site representative) should send a registered letter to the last carrier within 3 days of delivery.

Note: for deliveries in France, even concealed damage must be looked for at delivery and immediately treated as visible damage.

### Reception in all countries except France:

In case of concealed damage: The consignee (or the site representative) must send a registered letter to the last carrier within 7 days of delivery, claiming for the described damage. A copy of this letter must be sent to Trane Epinal Operations - Claims team.

# General information

---

## Warranty

Warranty is based on the general terms and conditions of the manufacturer. The warranty is void if the equipment is repaired or modified without the written approval of the manufacturer, if the operating limits are exceeded or if the control system or the electrical wiring is modified. Damage due to misuse, lack of maintenance or failure to comply with the manufacturer's instructions or recommendations is not covered by the warranty obligation. If the user does not conform to the rules of this manual, it may entail cancellation of warranty and liabilities by the manufacturer.

## Refrigerant

The refrigerant provided by the manufacturer meets all the requirements of our units. When using recycled or reprocessed refrigerant, it is advisable to ensure its quality is equivalent to that of a new refrigerant. For this, it is necessary to have a precise analysis made by a specialized laboratory. If this condition is not respected, the manufacturer warranty could be cancelled.

## Maintenance contract

It is strongly recommended that you sign a maintenance contract with your local Service Agency. This contract provides regular maintenance of your installation by a specialist in our equipment. Regular maintenance ensures that any malfunction is detected and corrected in good time and minimizes the possibility that serious damage will occur. Finally, regular maintenance ensures the maximum operating life of your equipment. We would remind you that failure to respect these installation and maintenance instructions may result in immediate cancellation of the warranty.

## Training

To assist you in obtaining the best use of it and maintaining it in perfect operating condition over a long period of time, the manufacturer has at your disposal a refrigeration and air conditioning service school. The principal aim of this is to give operators and technicians a better knowledge of the equipment they are using, or that is under their charge. Emphasis is particularly given to the importance of periodic checks on the unit operating parameters as well as on preventive maintenance, which reduces the cost of owning the unit by avoiding serious and costly breakdown.

# Contents

---

General Information	2
---------------------	---

## Installation

Unit nameplate	5
Installation instructions	5
Handling	5
Minimum water volume	6
Refrigerant lines CCUH	7
Refrigerant line connections - CCUH and remote condenser	8
Winter freeze protection	10
Water treatment	11
Compressor sequencing	11
Interconnection between CCUH and remote condenser	12
Electrical connections	12

<b>General data</b>	<b>14</b>
---------------------	-----------

## General start-up

Preparation	16
Start-up	16

## Operation

Control and Unit Operation	21
Weekly start up and week-end shutdown	21
Seasonal shutdown and start-up	21

## Maintenance

Maintenance instructions	22
Installation checklist	23
Troubleshooting guide	25

# Installation

## Unit nameplate

The unit nameplate gives the complete model reference numbers. The unit power rating is shown, and power supplies should not deviate by more than 5 % from the rated power.

Compressor motor amperage is shown in box I.MAX.

The customer's electrical installation must be able to withstand this current.

## Installation instructions

### Foundations

No special foundations are required, provided the supporting surface is flat and level, and can withstand the weight of the unit.

### Isolation rubber pads

They are supplied as standard with the machine, and should be placed between the supporting floor and the unit to isolate the unit from the ground (4 pads for the sizes 115 to 125 and 6 pads for the sized 225 to 250). To reduce vibration, Trane recommends the use of neoprene pads (not included) but does not allow the use of spring isolators.

### Water drain hole

Install a drain hole wide enough to drain away water from the unit in the event of shut-down or repair.

## Clearance

Respect recommended clearance around the unit to allow maintenance operation to take place without obstruction. Submittals are available on request from your local Trane Sales Office.

## Handling

A specific lifting method is recommended as follows:

1. 4 lifting points are built into the unit.
2. Slings and spreader bar to be provided by rigger and attached to the 4 lifting points.
3. Minimum rated lifting capacity (vertical) of each sling and spreader bar shall be no less than the tabulated unit shipping weight.

### CAUTION!

**The plates welded at the end of the bases must not be used for handling. Use the ones at 237 mm from the ends.**

*Figure 1 - Handling*

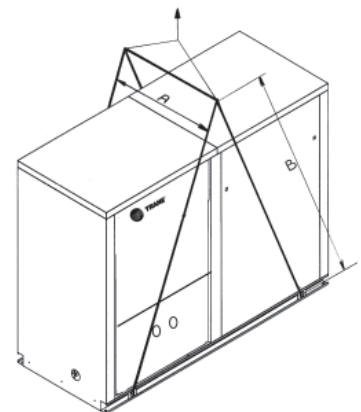

**Table 1 - Dimensions of recommended slings and swing-bar :**

Unit size	115	120	125	225	230	235	240	250
A (mm)	1400	1400	1400	1400	1400	1400	1400	1400
B (mm)	1900	1900	1900	1900	1900	1900	1900	1900
Weight (kg) CGWH	412	444	476	668	702	739	803	873
Weight (kg) CCUH	389	416	443	626	655	679	757	815

# Installation

**Before making any connections, make sure the labeling for entering and leaving water corresponds to the submittals.**

Install water circulation pump upstream of the evaporator, insuring that the evaporator is under positive pressure.

Tables for water connections diameter are shown on the certified submittals.

These drawings are available on request from your Trane Sales Office.

## Minimum water volume

Why is the water volume an important parameter?

The water volume is an important parameter because it allows a stable chilled water temperature and avoids short cycle operation of the compressors.

### Parameters which influence the water temperature stability

- Water loop volume.
- Load fluctuation.
- Number of capacity steps.
- Compressors rotation.
- Dead band (adjusted by control CH530).
- Minimum time between 2 starts of a compressor.

### Minimum water volume for a comfort application

For comfort application we can allow water temperature fluctuation at part load.

The parameter to take into account is the minimum operating time of the compressor. In order to avoid any lubrication problem, scroll compressor must run for at least 2 minutes (120 seconds) before it stops.

Figure 2

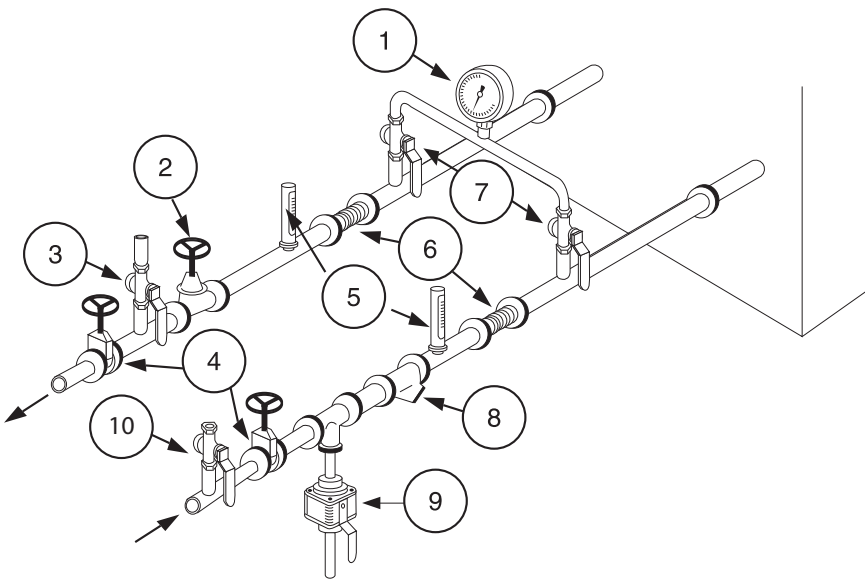

1. Pressure gauges: show entering and leaving water pressure (2 pressure ports are available inside of the unit - see item 1 in Figure 2)
2. Balancing valve: adjusts water flow.
3. Air purge: allows to remove the air from the water circuit during fill up.
4. Stop valves: isolate chillers and water circulating pump during maintenance operations.
5. Thermometers: indicate chilled water entering and leaving temperatures (not mandatory).
6. Expansion compensators: avoid mechanical stress between chiller and piping installation.
7. Stop valve located on the outlet connection: used to measure the water pressure inlet or outlet of evaporator.
8. Strainer: avoid getting heat exchangers dirty. All installation must be equipped with efficient strainer in order that only clean water enters into exchanger. If there is no strainer, reserve will be formulated by the Trane technician at the start-up of the unit. The strainer used must be able to stop all particles with a diameter greater than 1.6 mm.
9. Draining and charging: used to drain and charge the plate heat exchanger.
10. Charging valve

# Installation

The minimum volume can be determined by using the following formula : Volume = Cooling capacity x Time x highest capacity step (%) / Specific heat / Dead band.

Minimum operating time = 120 seconds.

Specific heat = 4.18 kJ / kg.

Average deadband = 3°C (or 2°C)

**Note: To estimate the biggest step, it is usually more reliable to make a selection at lower condensing temperature where efficiency is higher and compressor steps bigger. It is also essential to take into account the brine specific heat, in case of the use of glycol.**

## Refrigerant lines CCUH

Calculating and fixing the capacity of refrigerant lines is necessary to assure the oil return to the compressor, avoid refrigerant phase changes and limit pressure drop.

### Liquid lines

Calculate capacity of liquid line, as per the following criteria.

1. Maximum load operating conditions.
2. To avoid any evaporation risk:
  - Consider the vertical risers
  - Maximum pressure drop must not exceed 1 to 2°C
3. Liquid circulation speed in a 0.5 to 2m/s range.

## Insulation of refrigerant lines

Insulate refrigerant lines from building itself to avoid transmission to building structure of vibrations normally caused by pipework. Also avoid bypassing the unit's damping system by fixing the refrigerant lines or the electrical ducts very rigidly.

Vibrations may propagate into building structure through rigidly fixed refrigerant lines.

### Pressure tests. Leak detection

During operations, take the following precaution:

1. Neither oxygen nor acetylene should be used instead of refrigerant and nitrogen to detect leaks, otherwise a violent explosion may occur.
2. Always use valves and manometers to check the test pressure in system. Excessive pressure may either cause pipes to rupture, damage unit, or cause an explosion, causing possible physical injury. Carry out liquid line and hot gas pressure tests in accordance with current standards.

### CAUTION!

Do not go more than 0.7 bar above the high pressure switch setpoint. Introduce enough refrigerant into circuit for 85 to 100 kPa pressure, pump-injecting dry nitrogen, and raise pressure to 100 kPa. Search possible leaks using detector. This operation should be carried out great care throughout the system. If leaks are detected, reduce system pressure, and repair defective component. Repeat test process, to check that the repair can withstand rated pressure.

### NOTE:

CCUH is delivered with a nitrogen holding charge and isolating valves.

Table 2 - CGWH

Unit size		115	120	125	225	230	235	240	250
Cooling Capacity	(kW)	51	64	77	91	103	116	127	155
Biggest step	(%)	50	60	50	42	38	34	30	25
Biggest step	(kW)	26	38	39	38	39	39	38	39
Minimum water loop for comfort	(l)	244	368	368	365	375	377	365	371

This table is estimated with  
 - Condenser : Water 30°/35°C  
 - Evaporator : Water 12°/7°C  
 - Dead Band of 3°C

Table 3 - CCUH

Unit size		115	120	125	225	230	235	240	250
Cooling Capacity	(kW)	51	64	77	90	102	115	127	153
Biggest step	(%)	50	60	50	42	38	34	30	25
Biggest step	(kW)	26	38	38	38	39	39	38	38
Minimum water loop for comfort	(l)	244	367	367	363	371	374	365	366

This table is estimated with  
 - Condensing temp : 45°C with sub cooling 5°C  
 - Evaporator : Water 12°/7°C  
 - Dead Band of 3°C

Note: CCUH is only one component of a complete installation. It includes its own high pressure protection set at 29.5 bars.  
 The party in charge of the supply of the condenser and of its refrigerant piping is responsible of implementing all the required protections to comply with the PED requirements for the design pressure of the condenser installed. Please refer to the document PROD-SVX01\_xx delivered with this chiller to check all the mandatory conformity requirements of the Pressure Equipment and Machinery directives for this installation.

# Installation

## Refrigerant line connections - CCUH + remote condenser

### Piping

Maximum distances and refrigerant line diameters between units must be checked according to the configuration and system operating conditions (Chilled water temperature and subcooling).

Tables 4-7 provide the maximum acceptable height according to subcooling available and recommended diameters for discharge liquid lines when a CCUH condenserless chillers is connected to a remote condenser.

**CAUTION! CCUH is only a component of a complete installation. It includes its own high pressure protection set at 23 bar. The party in charge of the supply of the condenser and of its refrigerant piping is responsible for implementing all required protections to comply with PED requirements for the design pressure of the condenser installed. Refer to the document PROD-SVX01\_XX delivered with this chiller to check all the mandatory conformity requirements of the Pressure Equipment and Machinery directives for this installation.**

Figure 3 - Installation configuration - CCUH and remote condenser at the same level

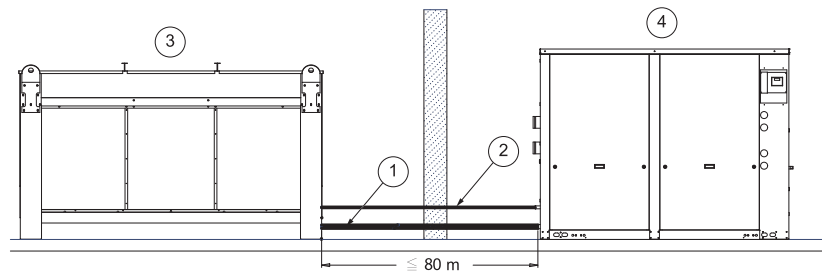

- 1: Discharge line
- 2: Liquid line
- 3: Remote condenser
- 4: CCUH





# Installation

The minimum required subcooling at the remote condenser level when installed below is defined in the following table.

**Table 4 - REQUIRED DISCHARGE LINE DIAMETER CCUH circuit 1 (for vertical risers)**

Unit size	Leaving chilled water temperature										
	-6	-4	-2	0	2	4	6	8	10	12	14
115		7/8"						1"1/8			
120		7/8"					1"1/8			1"3/8	
125	7/8"			1"1/8					1"3/8		
225		7/8"						1"1/8			
230	7/8"						1"1/8			1"3/8	
235	7/8"			1"1/8					1"3/8		
240		7/8"				1"1/8				1"3/8	
250	7/8"			1"1/8					1"3/8		

**Table 5 - REQUIRED DISCHARGE LINE DIAMETER CCUH circuit 2 (for vertical risers)**

Unit size	Leaving chilled water temperature										
	-6	-4	-2	0	2	4	6	8	10	12	14
225	7/8"						1"1/8				
230	7/8"						1"1/8				
235	7/8"						1"1/8				
240		7/8"					1"1/8			1"3/8	
250	7/8"			1"1/8					1"3/8		

**Table 6 - REQUIRED LIQUID LINE DIAMETER CCUH circuit 1 (either vertical or horizontal)**

Unit size	Leaving chilled water temperature										
	-6	-4	-2	0	2	4	6	8	10	12	14
115	5/8"						7/8"				
120				7/8"						1"1/8	
125	5/8"			7/8"					1"1/8		
225						7/8"					
230	5/8"				7/8"					1"1/8	
235			7/8"						1"1/8		
240	5/8"				7/8"					1"1/8	
250			7/8"						1"1/8		

**Table 7 - REQUIRED LIQUID LINE DIAMETER CCUH circuit 2 (either vertical or horizontal)**

Unit size	Leaving chilled water temperature										
	-6	-4	-2	0	2	4	6	8	10	12	14
225	5/8"						7/8"				
230	5/8"						7/8"				
235	5/8"						7/8"				
240				7/8"						1"1/8	
250			7/8"						1"1/8		

# Installation

## Winter freeze protection

During negative ambient air temperature chilled water piping must be fully insulated. Ensure that all safeties are taken to prevent frost damage during negative ambient air temperature. The following systems can be used:

- Electrical heater mounted on all water piping exposed to negative temperatures.
- Start chilled water pump during negative ambient air temperature.
- Add ethylene glycol in the chilled water.
- Drain water-circuit, however be aware of corrosion process when drained.

**CAUTION:** There is a risk of freezeup of the evaporator circuit due to internal refrigerant migration if the condenser circuit is maintained at a low temperature (below 0°C) for a long period during the cold season.

If necessary, provide isolation valves on the condenser water circuit (CGWH). CCUH is protected against refrigeration migration by a liquid solenoid valve.

Recommended ethylene and propylene glycol percentage are indicated in the General Start-up section.

Loading concentrated glycol in the water loop at the suction side of the pump is prohibited. It can severely damage the mechanical seal of the pump and consequently generate potential water leaks.

**Figure 4 - Freezing point versus ethylene glycol percentage**

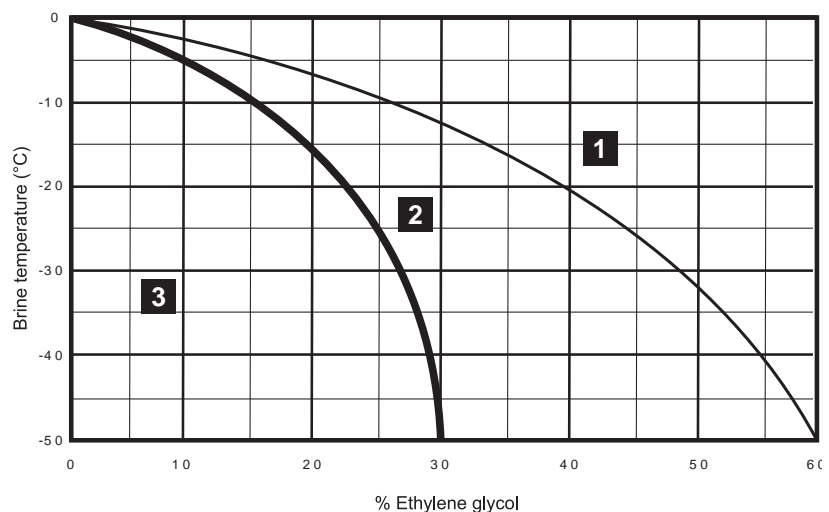

1. Liquid
2. Freezing without burst effect
3. Freezing with burst effect

# Installation

## Water treatment

Untreated or insufficiently treated water, if used in this unit, may cause scale, slime or algae to accumulate or cause erosion and corrosion. As Trane does not know the components used in the hydraulic network and the quality of the water used, we recommend the services of a qualified water treatment specialist.

The following materials are used in Trane chillers heat exchangers :

- Stainless steel plates AISI 316, 1.4401 with copper bracing.
- Water piping : copper 99,9 %
- Water connections : brass

Trane will not accept any liability in regards of damage due to the use of untreated or improperly treated water or from the use of saline or brackish water.

If required, contact your local Trane sales office.

## Compressor sequencing

Tables 8 and 9 show compressor sequencing at the start of the unit. «Balanced» means that there is no fixed sequence, Compressors are started in order to balance compressor total running times.

**Table 8**

Unit Model	Unit size	COMPRESSOR LOCATION				Recommended Sequence		Number of capacity stages
		Circuit 1		Circuit 2		Circuit 1	Circuit 2	
		1	2	3	4			
CGWH	115	10T	10T			Balanced		2
	120	10T	15T					3
	125	15T	15T					2
	225	10T	10T	15T	5			
	230	10T	15T	15T	5			
	235	15T	15T	15T	3			
	240	10T	15T	10T	15T			6
	250	15T	15T	15T	15T			4

**Table 9**

Unit Model	Unit size	COMPRESSOR LOCATION				Sequence		Number of capacity stages
		Circuit 1		Circuit 2		Circuit 1	Circuit 2	
		1	2	3	4			
CCUH	115	10T	10T			Balanced		2
	120	10T	15T			Comp 2 first		3
	125	15T	15T			Balanced		2
	225	10T	10T	15T	Balanced		5	
	230	10T	15T	15T	Comp 2 or 3 first, if 3, then 2 is second, comp 1 is 3rd		3	
	235	15T	15T	15T	Balanced		3	
	240	10T	15T	10T	15T	Comp 2 first	Comp 4 first	4
	250	15T	15T	15T	15T	Balanced		4



# Installation

---

## Electrical connections

### CAUTION!

1. The greatest care should be taken when cutting through passages and installing electric wiring. Under no circumstances should chips of metal or cuttings of copper or isolating material fall into the starter panel or electric components. Relays, contactors, terminals and control wiring should be covered and protected before power supplies are connected.
2. Install power supply cabling as shown in wiring diagram.

Adequate cable gland should be chosen, ensuring no foreign bodies enter the electrical housing or components.

### CAUTION!

1. Cabling must comply with standards in force. The type and location of fuses must also comply with standards. As a safety measure, fuses should be visibly installed, close to the unit.
2. Only copper wiring should be used. Using aluminium wires can produce galvanic corrosion and possibly lead to superheat and failure of connection points.

Trane provides a single power supply which includes the transformer.

Warranty reserves will be formulated if a transformer, not supplied by Trane, is installed inside the electric panel

## Interconnection between CCUH and Remote Condenser

The CCUH has the capability to control the fan staging of the remote condenser if the option is taken.

Each refrigerant circuit can control from one up to 6 fans per circuit using a 4 output relays (10A/250VAC/AC1/SPDT) card option provided in the control box the of CCUH. The external wiring to the remote condenser shall be connected directly to the terminal block for the optional fan relay cards.

### CAUTION!

Power supply to the outdoor fan relays shall not be provided from the CCUH unless special care about voltage and power consumption was evaluated.

# Installation

**Table 10 - Control output relays (CCUH)**

Output relay Quantity of fans	Fan 1		Fan 2	Fan 3	Fan 4	Fan 5	Fan 6	
	Low Speed	High Speed	Single speed			Fan option		
2	1	2	3&4			Two fan speed first fan		
	1		3&4			Single speed only fans		
3	1	2	3	4	Two fan speed first fan			
	1		3	4	Single speed only fans			
4	1	2	3	4	4	Two fan speed first fan		
	1		3	4	4	Single speed only fans		
5	1	2	3	3	4	4	Two fan speed first fan	
	1		3	3	4	4	Single speed only fans	
6	1	2	3	3	4	4	4	Two fan speed first fan
	1		3	3	4	4	4	Single speed only fans

**Table 11 - Fan staging - Example :4 fans per circuit, single speed (CCUH)**

Standard - 4 fans per circuit Relays Energized						
Stage	Number of Fans	1	2	3	4	Capacity [%]
0	0	0	0	0	0	0
1	1	1	0	0	0	25
2	2	1	0	1	0	50
3	3	0	0	1	1	75
4	4	1	0	1	1	100

**Table 12 - Fan staging - Example :4 fans per circuit with first fan 2-speed (CCUH)**

Low Ambient 2-Speed, 4 fans per circuit Relays Energized						
Stage	Number of Fans	1	2	3	4	Capacity [%]
0	0	0	0	0	0	0.00
1	0.5	1	0	0	0	12.50
2	1	0	0	1	0	25.00
3	1.5	1	0	1	0	37.50
4	2	0	0	0	1	50.00
5	2.5	1	0	0	1	62.50
6	3	0	0	1	1	75.00
7	3.5	1	0	1	1	87.50
8	4	0	1	1	1	100.00



## General data

Table 13 - R407C Refrigerant

		CGWH 115	CGWH 120	CGWH 125	CGWH 225	CGWH 230	CGWH 235	CGWH 240	CGWH 250
<b>Eurovent Performances (1)</b>									
Gross cooling capacity CGWH (1)		51.8	64.9	78	92.1	104.5	117.4	129.7	157.1
Gross power input CGWH (1)		13.8	17.6	21.3	24.3	27.9	31.3	35	41.9
Gross EER CGWH (1)		3.75	3.69	3.66	3.79	3.75	3.75	3.71	3.75
Gross ESEER CGWH		4.57	4.85	4.56	4.77	4.44	4.28	4.06	3.86
Net cooling capacity CGWH (1) (5)		51.4	64.5	77.5	91.5	103.8	116.7	128.8	156.1
Net power input CGWH (1) (5)		14.6	18.6	22.5	25.6	29.5	33	37.1	44.3
Net EER / Eurovent energy class CGWH (1) (5)		3.52/E	3.48/E	3.45/E	3.57/E	3.52/E	3.54/E	3.47/E	3.52/E
Net ESEER CGWH (5)		4.06	4.22	3.92	4.17	4.02	3.69	3.67	3.41
Evaporator water pressure drop	(kPa)	39	39	39	45	50	50	60	62
Condenser water pressure drop	(kPa)	62	63	64	71	79	78	94	95
Main Power supply	(V/Ph/Hz)	400/3/50							
Sound Power Level (5)	(dB(A))	75	79	81	81	82	83	82	84
<b>Units Amps</b>									
Nominal (4)	(A)	41	52	63	72	83	94	41	125
Start-up Amps	(A)	140	194	204	212	222	232	140	261
Max supply cable size	(mm <sup>2</sup> )	16	35	35	35	50	50	95	95
<b>Compressor</b>									
Number		2	2	2	3	3	3	4	4
Type		Scroll							
Model		10T+10T	10T+15T	2x15T	2x10T+15T	10T+2x15T	3x15T	2x(10T+15T)	4x15T
Number of speeds		1	1	1	1	1	1	1	1
Number of motors		1	1	1	1	1	1	1	1
Rated Amps (2)(4)	(A)	30	42	50	55	65	75	84	101
Locked rotor Amps (2)	(A)	120	175	175	175	175	175	175	175
Motor RPM	(rpm)	2900	2900	2900	2900	2900	2900	2900	2900
Sump Heater	(W)	10T compressor = 100W; 15T compressor = 160W							
<b>Evaporator</b>									
Number		1	1	1	1	1	1	1	1
Type		Braze plate							
Water volume (total)	(l)	4.7	5.9	7.0	8.9	10.3	12.3	12.3	16.1
Antifreeze Heater	(W)	-	-	-	-	-	-	-	-
<b>Evaporator Water Connections</b>									
Type		ISO R7 - Male							
Diameter		1"1/2	1"1/2	1"1/2	2"	2"	2"1/2	2"1/2	2"1/2
<b>Condenser</b>									
Number		1	1	1	1	1	1	1	1
Type		Braze plate	Braze plate	Braze plate	Braze plate	Braze plate	Braze plate	Braze plate	Braze plate
Water volume (total)	(l)	4.7	5.9	7.0	8.9	10.3	12.3	12.3	16.1
Antifreeze Heater	(W)	-	-	-	-	-	-	-	-
<b>Condenser Water Connections</b>									
Type ISO R7		Male	Male	Male	Male	Male	Male	Male	Male
Diameter		1"1/2	1"1/2	1"1/2	2"	2"	2"	2"1/2	2"1/2
<b>Dimensions</b>									
Height	(mm)	1545	1545	1545	1545	1545	1545	1545	1545
Length	(mm)	1101	1101	1101	2072	2100	2135	2145	2082
Width	(mm)	800	800	800	866	866	866	866	866
Weight uncrated	(kg)	412	444	476	668	702	739	803	873
<b>System Data</b>									
Refrigerant circuit		1	1	1	2	2	2	2	2
<b>Refrigerant Charge(3)</b>									
Circuit A	(kg)	5	7	9	5	7	9	7	9
Circuit B	(kg)	-	-	-	5	5	5	7	9

(1) at Eurovent Conditions (Evap 12°C/7°C - Cond. 30/35°C)

(2) per compressor

(3) per circuit

(4) 5°C sat suction temp. - 60°C sat discharge temp.

(5) At full load and in accordance with ISO 9614

## General data

Table 14 - R407C Refrigerant

		CCUH 115	CCUH 120	CCUH 125	CCUH 225	CCUH 230	CCUH 235	CCUH 240	CCUH 250
<b>Eurovent Performances (1)</b>									
Gross cooling capacity CCUH (2)	(kW)	51.3	64.3	77.3	91	103.2	115.4	128.4	154.7
Gross power input CCUH (2)	(kW)	14.2	17.9	21.7	25	28.8	32.6	35.9	43.5
Gross EER CCUH (2)		3.61	3.59	3.56	3.64	3.58	3.54	3.58	3.56
Evaporator water pressure drop	(kPa)	38	38	38	44	49	49	59	60
Main Power supply	(V/Ph/Hz)	400/3/50							
Sound Power Level (5)	(dB(A))	75	79	81	81	82	83	82	84
<b>Units Amps</b>									
Nominal (4)	(A)	41	52	63	72	83	94	41	125
Start-up Amps	(A)	140	194	204	212	222	232	140	261
Recommended Fuse Size (Am)	(A)	Depends on installation.							
Max supply cable size	(mm <sup>2</sup> )	16	35	35	35	50	50	95	95
Max. Wire Length	(m)	Depends on installation.							
<b>Compressor</b>									
Number		2	2	2	3	3	3	4	4
Type		Scroll							
Model		10T+10T	10T+15T	2x15T	2x10T+15T	10T+2x15T	3x15T	2x(10T+15T)	4x15T
Speeds number		1	1	1	1	1	1	1	1
Motors Number		1	1	1	1	1	1	1	1
Rated Amps (2)(4)	(A)	30	42	50	55	65	75	84	101
Locked rotor Amps (2)	(A)	120	175	175	175	175	175	175	175
Motor RPM	(rpm)	2900	2900	2900	2900	2900	2900	2900	2900
Sump Heater (2)	(W)	50W - 400V							
<b>Evaporator</b>									
Number		1	1	1	1	1	1	1	1
Type		Brazen plate							
Model		V45-40	V45-50	V45-60	DV47-74	DV47-86	DV47-102	DV47-102	DV47
Water volume (total)	(l)	4.7	5.9	7	8.9	10.3	12.3	12.3	16.1
Antifreeze Heater	(W)	-	-	-	-	-	-	-	-
<b>Evaporator Water Connections</b>									
Type		ISO R7 - Male							
Diameter		1 1/2"	1 1/2"	1 1/2"	2"	2"	2 1/2"	2 1/2"	2 1/2"
<b>Discharge and liquid connections</b>									
Type		Brazen - Female							
Discharge connection		1 1/8" ODF	1 3/8" ODF	1 3/8" ODF	1 1/8" ODF	1 3/8" ODF	1 3/8" ODF	1 3/8" ODF	1 3/8" ODF
Liquid connection		7/8" ODF	7/8" ODF	7/8" ODF	7/8" ODF	7/8" ODF	7/8" ODF	7/8" ODF	7/8" ODF
<b>Dimensions</b>									
Height	(mm)	1545	1545	1545	1545	1545	1545	1545	1545
Length	(mm)	1136	1136	1136	2162	2190	2225	2235	2172
Width	(mm)	800	800	800	880	880	880	880	880
Weight uncrated	(kg)	389	416	443	626	655	689	757	815
<b>System Data</b>									
Refrigerant circuit		1	1	1	2	2	2	2	2
Total refrigerant content of evaporator	(kg)	4	5	6	7	9	10	10	13
Holding Charge		Nitrogen							

(1) at Eurovent Conditions (Evap 12°C/7°C - Cond. 45°C - SC 5K)

(2) per motor

(3) per circuit

(4) 5°C sat suction temp. - 60°C sat discharge temp.

(5) At full load and in accordance with ISO 9614. Sound level affected by the design of the discharge line to the remote condenser.

## General start-up

### Preparation

Carry out all operations on check list and that the unit is correctly installed and ready to operate. The installer must check all the following points before calling in the Trane Servicing Department to put the equipment into service:

- Check position of unit
- Check unit is level
- Check type and position of rubber pads
- Check clearance required for maintenance access (See submittals)
- Chilled water circuit ready to operate, filled with water, pressure test carried out and air purged.
- Chilled water circuit must be rinsed
- Check the presence of water strainer ahead of evaporator
- The strainers must be cleaned after 2 hours of pumps operation
- Check the thermometers and manometers position
- Check chilled water pumps interconnection to control panel
- Insure that the isolation resistance of all power supply terminals to ground complies with standards and regulations in force.
- Check that unit voltage and frequency supplied match rated input voltage and frequency
- Check that all electrical connections are clean and sound
- Check that main power supply switch is sound.
- Check Ethylene glycol % in the chilled water circuit if Ethylene glycol presence is required.
- Check chilled water pressure drop through evaporator is in accordance with the Trane order write-up (See Tables 13-14).
- On start-up of each motor in the system, check the direction of rotation and operation of all the components they drive
- Water flow control checking: decrease the water flow and check the electrical contact in the control panel.
- Check that there is sufficient demand for cooling on the day of start-up (around 50% of nominal load) start-up (around 50% of nominal load)

### Start-up

Follow the instructions below to correctly start-up the unit.

#### Installation and chiller inspection:

- Ensure that all the operations above (start-up preparation), are followed.

Follow the instruction stuck inside the electrical cabinet:

- Unscrew the screws securing the isolators located under the rails supporting the compressor.
- Put the plexiglass supplied by Trane in front of the power terminal.
- Insure all water and refrigerant valves are in service positions,
- Insure that the unit is not damaged,
- Insure that sensors are properly installed in their bulb-wells and submerged in heat conducting product,
- Check fixing of capillary tubes (protection from vibration and from wear) and insure that they are not damaged,
- Reset all manually set control devices,
- Check refrigerating circuits tightness

#### Checking and setting:

Compressors:

- Check oil level at rest. The level should reach at least halfway up indicator located on housing. See fig. 6 for correct level.

Figure 5

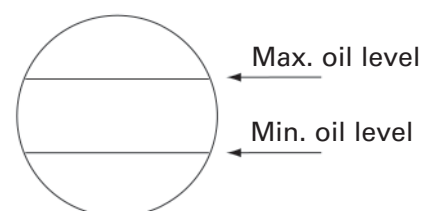



## General start-up

- Check fixing of capillary tubes (protection from vibration and from wear) and insure that they are not damaged,
- Reset all manually set control devices,
- Check refrigerating circuits tightness
- Check oil acidity,
- Check electrical terminals tightening of the motors and in the control panel,
- Check the isolation of the motors using a 500V DC megohmmeter which meets manufacturer's specifications (minimum value 2 megohms)
- Check the direction of the rotation using phasemeter.

### Electrical power wiring:

- Check all the electrical terminals tightening,
- Set-up compressors overload relays,

### Electrical control wiring

- Check all the electrical terminals tightening,
- Check all the pressostats,
- Check and set-up the CH530 control module
- Test and start-up without the electrical power.

### Condenser:

- Check setting of the safety pressure valve,
- Check the isolation of the motors using a 500V DC megohmmeter which meets manufacturer's specifications (minimum value 2 megohms)

### Operating parameters statement

- Switch on main power supply switch,
- Start the water pump(s),
- Start up the unit with the CH530 by pushing «Auto». The unit and the chilled water pumps contactor must be connected,
- After unit start up, leave in operation for at least 15 minutes, to insure pressures are stabilized.

### Then check:

- voltage,
- compressors currents,
- leaving and return chilled water temperature,
- suction temperature and pressure,
- ambient air temperature,
- blowing air temperature,
- discharge pressure and temperature,
- liquid refrigerant temperature and pressure,
- operating parameters:
- chilled water pressure drops through evaporator. It must be in accordance with Trane order write-up,
- superheat: difference between suction temperature and dew point temperature. Normal superheat must be within 5°C and 10°C,

- sub-cooling: difference between liquid temperature and bubble point temperature.
- difference between dew point temperature in high pressure and condenser air inlet temperature.
- difference between outlet water temperature and dew point temperature in low pressure.

Normal value on standard unit, without Ethylene glycol in chilled water, should be 4 to 6°C. With 407C, it should be about 3°C.

## General start-up

### Operating parameters

- chilled water pressure drop through evaporator (if no hydraulic module is installed) or unit available pressure. It must be in accordance with Trane order write-up.
- superheat: difference between suction temperature and dew point temperature. Normal superheat should be within 4 and 7 °C with R407C.
- sub-cooling: difference between liquid temperature and bubble point temperature. Normal subcooling should be within 2 and 10°C with R407C.
- Condenser approach: difference between dew point temperature in high pressure and condenser air inlet temperature. Normal value on standard unit with R407C, should be 15 to 23°C at full load.
- Evaporator approach: difference between outlet water temperature and dew point temperature in low pressure. Normal value on standard unit, without Ethylene glycol in chilled water, should be about + 2-3°C.

### Final check:

When the unit is operating correctly:

- Check that the unit is clean and clear of any debris, tools, etc...
- All valves are in operating position,
- Close control and starter panel doors and check panels fixation.

### CAUTION !

- For the warranty to apply, any start-up carried out directly by the customer must be recorded in a detailed report, which must be sent as soon as possible to the nearest Trane office.
- Do not start-up a motor whose insulation resistance is less than 2 megohms
- Phase imbalance should not be greater than 2%.
- The voltage supplied to motors should be within 5% of the rated voltage on the compressor nameplate.
- Excessive emulsion of the oil in the compressor shows that refrigerant is present in the oil and the result will be that compressor is not lubricated enough. Shut down compressor and consult Trane technician.
- Excess oil in compressor can damage the compressor. Before adding oil, consult Trane technician. Use only Trane products recommended.
- The compressors must operate in a single direction of rotation. If refrigerant high pressure remains stable in the 30 seconds after compressor start-up, immediately shut down unit and check the direction of rotation using phasemeter.

### CAUTION !

- The chilled water circuit may be under pressure. Bring down this pressure before opening up the system to rise out or fill up the water circuit. Failure to comply with this instruction may cause accidental injury to maintenance personnel.
- If a cleaning solution is used in the chilled water circuit, the chiller must be isolated from the water circuit to avoid all the damage risks of the chiller and evaporator water pipes.

### Refrigerant charge - CCUH

After system pressure and vacuum testing, fill up unit with refrigerant as per indicated in Table 13-14. The refrigerant complement will be charged according to the diameter and the length of the refrigerant piping to obtain the correct subcooling temperature:  $Dt \text{ subcooling} = 5^{\circ}\text{C}$  for a liquid temperature of 40°C.

### Oil charge

The oil quantity for the split system must be adjusted according to the diameter and length of the refrigerant piping.

**Table 15 - Oil charge per compressor**

Compressor	L
10T	3.8
15T	6.6

**CAUTION!** Use exclusively PEO oil recommended by Trane.

CCUH is delivered with a nitrogen holding charge.

## General start-up

**Table 16 - Evaporator pressure drop (CGWH/CCUH)**

DP kPa	Water flow - l/s							
	CGWH/CCUH 115	CGWH/CCUH 120	CGWH/CCUH 125	CGWH/CCUH 225	CGWH/CCUH 230	CGWH/CCUH 235	CGWH/CCUH 240	CGWH/CCUH 250
	10	1.16	1.45	1.74	1.87	2.01	2.16	2.16
20	1.63	2.05	2.45	2.67	2.86	3.14	3.14	3.73
40	2.30	2.89	3.45	3.81	4.08	4.55	4.55	5.43
60	2.82	3.53	4.22	4.69	5.02	5.65	5.65	6.78
80	3.25	4.07	4.86	5.43	5.82	6.59	6.59	7.93
100	3.63	4.55	5.43	6.09	6.53	7.43	7.43	8.95

**Table 17 - Condenser pressure drop (CGWH)**

DP kPa	Water flow - l/s							
	CGWH 115	CGWH 120	CGWH 125	CGWH 225	CGWH 230	CGWH 235	CGWH 240	CGWH 250
10	1.34	1.68	2.01	2.17	2.33	2.51	2.51	2.96
20	1.89	2.37	2.84	3.09	3.32	3.64	3.64	4.32
40	2.67	3.35	4.00	4.41	4.74	5.28	5.28	6.30
60	3.27	4.10	4.89	5.44	5.83	6.56	6.56	7.86
80	3.77	4.72	5.64	6.30	6.76	7.65	7.65	9.20
100	4.21	5.28	6.30	7.07	7.57	8.62	8.62	10.38

**Table 18 - Evaporator pressure drop + filter tamis type 202 (CGWH/CCUH)**

DP kPa	Water flow - l/s							
	CGWH/CCUH 115	CGWH/CCUH 120	CGWH/CCUH 125	CGWH/CCUH 225	CGWH/CCUH 230	CGWH/CCUH 235	CGWH/CCUH 240	CGWH/CCUH 250
	10	1.06	1.26	1.43	1.61	1.70	1.77	1.96
20	1.48	1.76	1.98	2.27	2.38	2.51	2.82	3.21
40	2.07	2.45	2.76	3.19	3.35	3.55	4.05	4.63
60	2.52	2.98	3.34	3.90	4.09	4.35	5.01	5.73
80	2.90	3.42	3.83	4.50	4.71	5.03	5.83	6.67
100	3.23	3.81	4.26	5.02	5.25	5.63	6.55	7.51

**Table 19 - Condenser pressure drop + filter tamis type 202 (CGWH)**

DP kPa	Water flow - l/s							
	CGWH/CCUH 115	CGWH/CCUH 120	CGWH/CCUH 125	CGWH/CCUH 225	CGWH/CCUH 230	CGWH/CCUH 235	CGWH/CCUH 240	CGWH/CCUH 250
10	1.19	1.40	1.56	1.79	1.87	1.94	2.20	2.48
20	1.66	1.94	2.17	2.51	2.62	2.74	3.16	3.57
40	2.32	2.71	3.00	3.52	3.67	3.86	4.54	5.13
60	2.82	3.28	3.63	4.29	4.47	4.72	5.61	6.34
80	3.24	3.76	4.16	4.94	5.14	5.44	6.52	7.37
100	3.61	4.18	4.62	5.51	5.73	6.08	7.32	8.29

# General start-up

**Figure 6 - Ethylene glycol recommended concentration**

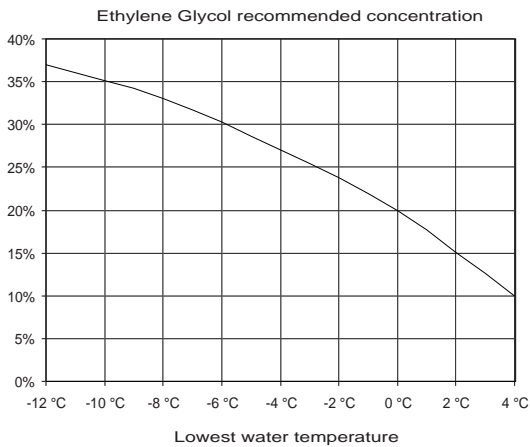

**Figure 7 - Propylene glycol recommended concentration**

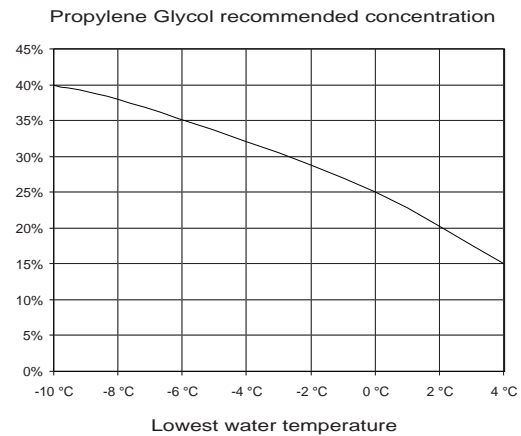

**Table 20 - Correction factors to apply when glycol is used in water loops**

Fluid type	Glycol Concentration		Performance		Evaporator		Condenser	
	Evaporator	Condenser	F-CC	F-PI	F-FLEVP	F-PDEVP	F-FLCDS	F-PDCDS
Water only	0%	0%	1.00	1.00	1.00	1.00	1.00	1.00
	10%	0%	0.99	1.00	1.02	1.02	1.00	1.00
	20%	0%	0.98	1.00	1.05	1.06	1.00	1.00
Ethylene Glycol	30%	0%	0.97	1.00	1.10	1.10	1.00	1.00
	0%	10%	1.00	1.00	1.00	1.00	1.02	1.05
	0%	20%	1.00	1.01	1.00	1.00	1.04	1.09
	0%	30%	1.00	1.02	1.00	1.00	1.08	1.14
	10%	0%	0.99	1.00	1.01	1.05	1.00	1.1
	20%	0%	0.97	1.00	1.03	1.10	1.00	1.00
Mono-Propylene Glycol	30%	0%	0.96	1.00	1.05	1.17	1.00	1.01
	0%	10%	1.00	1.01	1.00	1.00	1.01	1.06
	0%	20%	1.00	1.01	1.00	1.00	1.02	1.13
	0%	30%	0.99	1.02	1.00	1.00	1.05	1.21

The correction factors found in Table 20 can be applied as follows:

- Cooling capacity with glycol [kW]** = **F-CC** x Cooling capacity water [kW] (found in Tables 14-15)
- Power Input with glycol [kW]** = **F-PI** x Power Input water [kW] (found in Tables 1-4)
- Water Flow Evaporator with glycol [Litres/sec]** = **F-FLEVP** x Cooling capacity with glycol [kW] x 0.239 x (1 / Delta T Evaporator [°C])

**4. Water Pressure drop Evaporator with glycol [kPa]** = **F-PDEVP** x Water Pressure drop Evaporator water [kPa] (found in Table 16)

CGWH Only:

**5. Water Flow Condenser with glycol [Litres/sec]** = **F-FLCDS** x (Cooling capacity with glycol [kW] + Power input with glycol [kW]) x 0.239 x (1 / Delta T Condenser [°C])

**6. Water Pressure drop Condenser with glycol [kPa]** = **F-PDCDS** x Water Pressure drop Condenser water [kPa] (found in Table 17)

In case of application with negative temperature at the evaporator, combination of simultaneous usage of glycol both in evaporator and condenser, or usage of another type of fluid: please contact your local Trane sales representative.

# Operation

---

## Control System

The control is through the CH530 control module.

## Unit operations

- Check the chilled water pump(s) operates
- Start the unit with the CH530 by pushing «Auto». The unit will operate correctly when there is sufficient water flow. The compressors will start up if the evaporator water leaving temperature is above the control module setpoint.

## Weekly start up

- Check the chilled water pump(s) operates
- Push «Auto» on the module to allow chiller operation.

## Week end shutdown

- If the unit needs to be shut down for a short period of time,
- Stop the unit with the CH530 by pushing «Stop».
- If the unit is shut down for a longer period, see under «Seasonal shutdown», below.
- Ensure that all the safeties are taken to protect the compressor against refrigeration migration
- **Do not put the general and control disconnect switches to off.**

## Seasonal shutdown

- Check water flows and interlocks.
- Check Ethylene glycol % in the chilled water circuit if glycol presence is required
- Carry out leak test.
- Carry out oil analysis
- Record operating pressures, temperatures, amperages and voltage.

- Check operation of machines/ compare conditions of operation against original commissioning data.
- Stop the unit with the CH530 by pushing «Stop».
- Ensure that all the safeties are taken to protect the compressor against refrigeration migration
- Fill out the visit log sheet and review with the operator
- **Do not put the general and control disconnect switches to off.**

## Seasonal start-up

- Check water flows and interlocks.
- Check Ethylene glycol % in the chilled water circuit if glycol presence is required
- Check operational set points and performance.
- Calibrate controls.
- Check operation of all safety devices.
- Inspect contacts and tighten terminals.
- Megger the motor compressor windings.
- Record operating pressures, temperatures, amperages and voltage.
- Carry out leak test.
- Check configuration of unit control module.
- Change the oil as required based upon results of the oil analysis made during seasonal shutdown
- Check operation of machines/ compare conditions of operation against original commissioning data.
- Fill out the visit log sheet and review with the operator



# Maintenance

## Maintenance instructions

The following maintenance instructions are part of maintenance operations required for this equipment. A qualified technician is needed for regular maintenance as part of a regular maintenance contract. Carry out all operations as required by schedule. This will insure long unit service life and reduce the possibility of serious and costly breakdown. Keep service records up to date, showing monthly information on unit operations.

These records can be of great help to maintenance personnel diagnostics. Similarly, if machine operator keeps a log of changes in unit operating conditions, problems can be identified and solutions found before more serious problems arise.

## Inspection visit after the first 500 hours of operation from unit start up

- Carry out oil analysis
- Carry out leak test.
- Inspect contacts and tighten terminals.
- Record operating pressures, temperatures, amperages and voltage.
- Check operation of machines/ compare conditions of operation against original commissioning data.
- Fill out inspection visit log sheet and review with the operator

## Monthly preventive visit

- Carry out leak test.
- Oil test of acidity
- Check Ethylene glycol % in the chilled water circuit if glycol presence is required
- Inspect contacts and tighten terminals.
- Record operating pressures, temperatures, amperages and voltage.
- Check operation of machines/ compare conditions of operation against original commissioning data.
- Fill out visit log sheet and review with the operator.

## Annual preventive visit

- Check water flows and interlocks.
- Check Ethylene glycol % in the chilled water circuit if glycol presence is required
- Check operational set points and performance.
- Calibrate controls.
- Check operation of all safety devices.
- Inspect contacts and tighten terminals.
- Megger the motor compressor windings.
- Record operating pressures, temperatures, amperages and voltage.
- Carry out leak test.
- Check configuration of unit control module.
- Carry out oil analysis
- Change the oil as required based upon results of the oil analysis
- Check operation of machines/ compare conditions of operation against original commissioning data.

Fill out the annual start up visit log sheet and review with the operator.

## CAUTION !

- Please refer to specific Trane documentation on oil, available from your nearest Trane office. Oils recommended by Trane have been exhaustively tested in Trane laboratories to the specific requirement of Trane chiller and hence the user's requirements. Any use of oils not meeting specifications recommended by Trane is the responsibility of the user only, who thereby is liable to warranty loss.
- Oil analysis and oil test acidity must be carried out by a qualified technician. Poor interpretation of results may cause unit operating problems. Also, oil analysis must follow the correct procedures, to avoid accidental injury to maintenance personnel.
- If the condensers are dirty, clean them with brush. If the coils are too dirty, consult a cleaning professional. Never use water to clean condenser coils.
- Contact Trane Service for information on maintenance contracts.

## WARNING !

- Switch off unit main power supply before to any intervention. Failure to follow this safety instruction can lead to accident death of the maintenance personnel and may also destroy equipment.
- Never use steam or hot water above 55°C to clean condenser coils. The resulting increasing pressure could cause refrigerant lost through the safety valve.



## INSTALLATION CHECKLIST

### CGWH Trane Water Cooled Liquid Chiller

This list must be checked off by the installer to ensure correct installation before the unit starts up.

#### Unit acceptance

- Check for damage, if any, on transportation
- Check for equipment shipped against delivery slip
- Check lifting system

#### Unit positioning

- Remove packaging
- Check position of unit
- Check unit is level
- Check clearance required for maintenance access
- Check position of rubber pads

#### Chilled water circuit

- Check presence of strainers ahead of evaporator and condenser
- Check the tightness of the water circuit
- Check thermometer positioning
- Check manometer positioning
- Check chilled water flow rate balancing system
- Check rinsing and filling of chilled water pipes
- Check pump operation and water flow

#### Electrical equipment

- Check direction of rotation of compressors
- Check chilled water pump drive rotation
- Check installation and rating of mains power switch/fuse
- Check that electrical connections comply with specification
- Check that electrical connections match information on manufacturer's identification plate
- Check electrical connections and connections to mains power switch
- Water pressure switch

#### General

- Check available cooling charge (50% of rated installation load)
- Check with other trades handling installation works

Comments: .....

.....

.....

.....

Signature: ..... Name.....

Order N°: .....

Work site: .....

Please return to your local Trane Service Office



## INSTALLATION CHECKLIST

### CCUH Trane Condenserless Chiller

This list must be checked off by the installer to ensure correct installation before the unit starts up.

#### Unit acceptance

- Check for damage, if any, on transportation
- Check for equipment shipped against delivery slip
- Check lifting system

#### Unit positioning

- Remove packaging
- Check position of unit
- Check unit is level
- Check clearance required for maintenance access
- Check position of rubber pads

#### Chilled water circuit

- Check thermometer and manometer presence and positioning
- Check chilled water flow rate balancing system
- Check presence of strainer ahead of evaporator
- Check the tightness of the water circuit
- Check rinsing and filling of chilled water pipes
- Check pump operation and water flow

#### Electrical equipment

- Check installation and rating of mains power switch/fuses
- Check that electrical connections comply with specification
- Check that electrical connections are in accordance with information on manufacturer's identification plate
- Check direction of rotation of compressors
- Check chilled water pump drive rotation
- Check electrical connections and connections to mains power switch

#### General

- Check available cooling charge (50% of rated installation load)
- Check with other trades handling installation works

Comments: .....

.....

.....

.....

Signature: ..... Name:.....

Order N°: .....

Work site: .....

Please return to your local Trane Service Office



## Troubleshooting guide

These are simple diagnostic hints. If there is a breakdown, the Trane Service office should be contacted for confirmation and assistance.

<i>Problems symptoms</i>	<i>Problem cause</i>	<i>Action recommended</i>
<b>A) The compressor does not start up</b>		
Compressor terminals are live but motor does not start	Motor burned out.	Replace compressor
Contactors motor not operational.	Coil burned out or broken contacts.	Repair or replace.
No current ahead of motor contactor.	a) Power cut. b) Main power supply switched off.	Check fuses and connection. See why system tripped. If system is operational, switch on main power supply.
Current ahead of fuse, but not on contactor side.	Fuse blown.	Check motor insulation. Replace fuse.
Low voltage reading on voltmeter.	Voltage too low.	Contact Power Supply Utility.
Starter coil not excited.	Control circuit open.	Locate regulation device which has tripped out and see why. See instructions concerning this device. Replace compressor.
Compressor does not run. Compressor motor "groans". High pressure switch tripped to contacts open on high pressure. Discharge pressure too high.	Compressor sticking (damaged or sticking components). Discharge pressure too high	See instructions for "discharge pressure high".
<b>B) Compressor stops High pressure switch tripped.</b>		
Over current thermal relay tripped. Motor temperature thermostat tripped. Anti-freeze security tripped.	Discharge pressure too high. a) Voltage too low. b) Cooling demand too high, or condensing temperature too high. Not enough cooling fluid. Water flow to evaporator too low.	See instructions for "discharge pressure high". a) Contact Power Supply Utility. c) See instruction "discharge pressure too high". Repair leak. Add refrigerant. Check water flow rate, and pressure switch contact in water.
<b>C) Compressor stops just after its start</b>		
Suction pressure too low. Filter drier iced up.	Filter drier clogged.	Replace filter drier.



<i>Problems symptoms</i>	<i>Problem cause</i>	<i>Action recommended</i>
<b>D) The compressor keeps running without stopping</b>		
Temperature too high in areas requiring air-conditioning.	Excess load on cooling system.	Check thermal insulation and air-tightness of areas requiring air-conditioning.
Chilled water temperature output too high.	Existing cooling demand on system.	Check thermal insulation and air-tightness of areas requiring air-conditioning.
<b>E) Loss of oil in compressor</b>		
Oil level too low in indicator.	Not enough oil.	Contact Trane Office before to order oil
Gradual fall in oil level.	Filter drier clogged.	Replace filter drier.
Suction line too cold.	Liquid flows back to compressor.	Adjust superheat and check bulb fixing of the expansion valve.
<b>F) Compressor noisy</b>		
Compressor knocks.	Components broken in compressor.	Change compressor.
Suction line abnormally cold.	a) Uneven liquid flow. b) Expansion valve locked in open position.	a) Check superheat setting and fixing of expansion valve bulb. b) Repair or replace.
<b>G) Insufficient cooling capacity</b>		
Thermostatic expansion valve "whistles".	Not enough refrigerant.	Check refrigerant circuit tightness and add refrigerant.
Excess pressure drops through filter drier.	Drier filter clogged.	Replace.
Excessive superheat.	Superheat not properly adjusted.	Check adjustment of superheat and adjust thermostatic expansion valve.
Insufficient water flow.	Chilled water pipes obstructed.	Clean pipes and strainer.
<b>H) Discharge pressure too high</b>		
Condenser abnormally hot.	Presence of uncondensable liquids in system, or excess refrigerant.	Purge uncondensable fluids and drain off excess refrigerant.
Chilled water leaving temperature too high.	Overload on cooling system.	Reduce load on system. Reduce water flow if necessary.
Condenser air output too hot.	Reduced air flow. Air intake temperature higher than specified for unit.	Clean battery. Check operation of motor fans.

<i>Problems symptoms</i>	<i>Problem cause</i>	<i>Action recommended</i>
<b>I) Suction pressure too high</b>		
Compressor operates continuously.	a) Expansion valve too far open.	Check system.
Suction duct abnormally cold. Refrigerant flows back to compressor.	b) Expansion valve locked in open position.	a) Check for superheat and check that expansion valve bulb is secure. b) Replace.
<b>J) Suction pressure too low</b>		
Excessive pressure drop through filter drier. Refrigerant does not flow through thermostatic expansion valve.	Drier filter clogged. Expansion valve bulb has lost its refrigerant.	Replace the deshydrator. Replace the bulb.
Loss of power.	Expansion valve obstructed.	Replace.
Superheat too low.	Excessive pressure drops through evaporator.	Check adjustment of superheat and adjust thermostatic expansion valve.
<b>K) Insufficient cooling capacity</b>		
Low pressure drops through evaporator.	Low water flow rate.	Check water flow. Check state of strainers, check for obstruction in chilled water pipes.
Excess cooling demand on evaporator.		Check pressure switch contact in water.

## Caution

The above is not a comprehensive analysis of the Scroll compressor refrigeration system. The aim is to give operators simple instructions on basic unit processes so that they have the technical knowledge to identify and bring defective operations to the notice of qualified technicians.



Trane optimizes the performance of homes and buildings around the world. A business of Ingersoll Rand, the leader in creating and sustaining safe, comfortable and energy efficient environments, Trane offers a broad portfolio of advanced controls and HVAC systems, comprehensive building services, and parts. For more information, visit [www.Trane.com](http://www.Trane.com).

Trane has a policy of continuous product and product data improvement and reserves the right to change design and specifications without notice.