

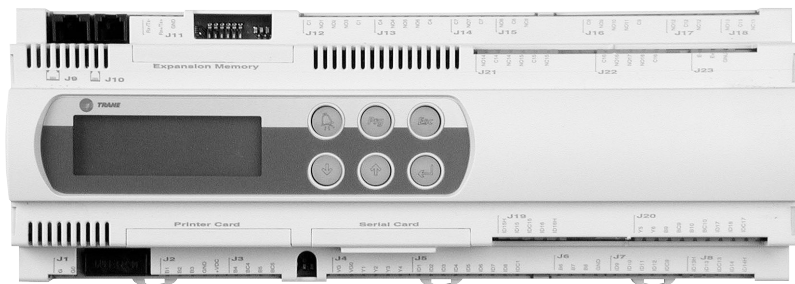

TRACER CH532 Chiller controller User guide

AquaStream²®



CG-SVU01B-E4

General information

Foreword

These Installation Operation and Maintenance instructions are given as a guide to good practice in the installation, start-up, operation and periodic maintenance by the user of TRACER CH532 chiller controller. They do not contain the full service procedures necessary for the continued successful operation of this equipment. The services of a qualified service technician should be employed, through the medium of a maintenance contract with a reputable service company.

Warranty

Warranty is based on the general terms and conditions of the constructor. The warranty is void if the equipment is modified or repaired without the written approval of the constructor, if the operating limits are exceeded, or if the control system or the electrical wiring is modified. Damage due to misuse, lack of maintenance, or failure to comply with the manufacturer's instructions, is not covered by the warranty obligation. If the user does not conform to the rules of "Maintenance", it may entail cancellation of warranty and liabilities by the constructor.

Reception

When the unit arrives on site, check it has not been damaged in any way during transport. If damage is observed, or even merely suspected, notify the carrier within 24 hours by registered letter. Notify the local Trane Sales office at the same time. The unit should be totally inspected within 3 days of delivery. If damage is observed, notify the last carrier by registered letter and notify the local sales office.

General information

About this manual

Cautions appear at appropriate places in this instruction manual. Your personal safety and the proper operation of this machine require that you follow them carefully. The constructor assumes no liability for installations or servicing performed by unqualified personnel.

Contents

Foreword	2
Warranty	2
Reception	2
General information	2
TRACER CH532 Presentation	4
Hardware architecture	5
Starting/stopping the unit	9
Menus	10
Display menu: "Data display"	11
Customer settings menu: "Settings"	12
Clock Setting menu: "Clock"	15
Unit configuration menu: "Configuration"	17
Alarms	22
LonTalk [®] option	25
Safety recommendations	32
Maintenance contract	32
Training	32

TRACER CH532 Presentation

Important note: This document describes all the functions available on TRACER CH532 with software version 2.0 and explains how to program it.

Certain parameters must only be modified by qualified personnel. Before changing any parameter, always check that the change does not affect the good and safe operation of the equipment. Operation must always stay in the catalogued limits.

Built-in control terminal features:
 An LCD display (1), 4 lines x 20 characters with back lighting
 6 buttons (2) to (7)

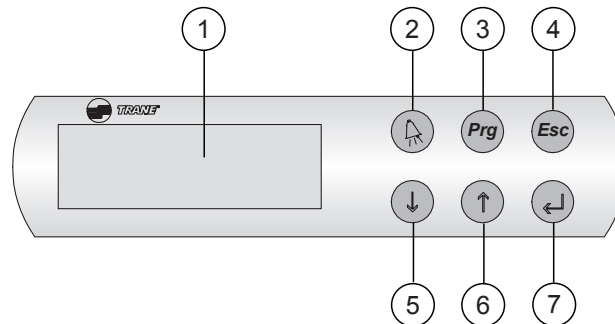

Figure 1 - TRACER CH532 user interface



2.  **Alarm button:**
 Used for displaying or manually resetting the alarms. The red LED lights up, when at least one alarm has been detected.

3.  **Program button:**
 Allows the various operating parameters to be set (safety parameters, thresholds).

4.  **Escape button:**
 Allows the return to default display

5.6.   **Downward and Upward arrows**
 Allows management of currently displayed screen and setting of values of control parameters

7.  **Validation button**
 Allows to move from line to line in the currently displayed screen and to confirm the set data.

Hardware architecture

Figure 2 - TRACER CH532 inputs and outputs

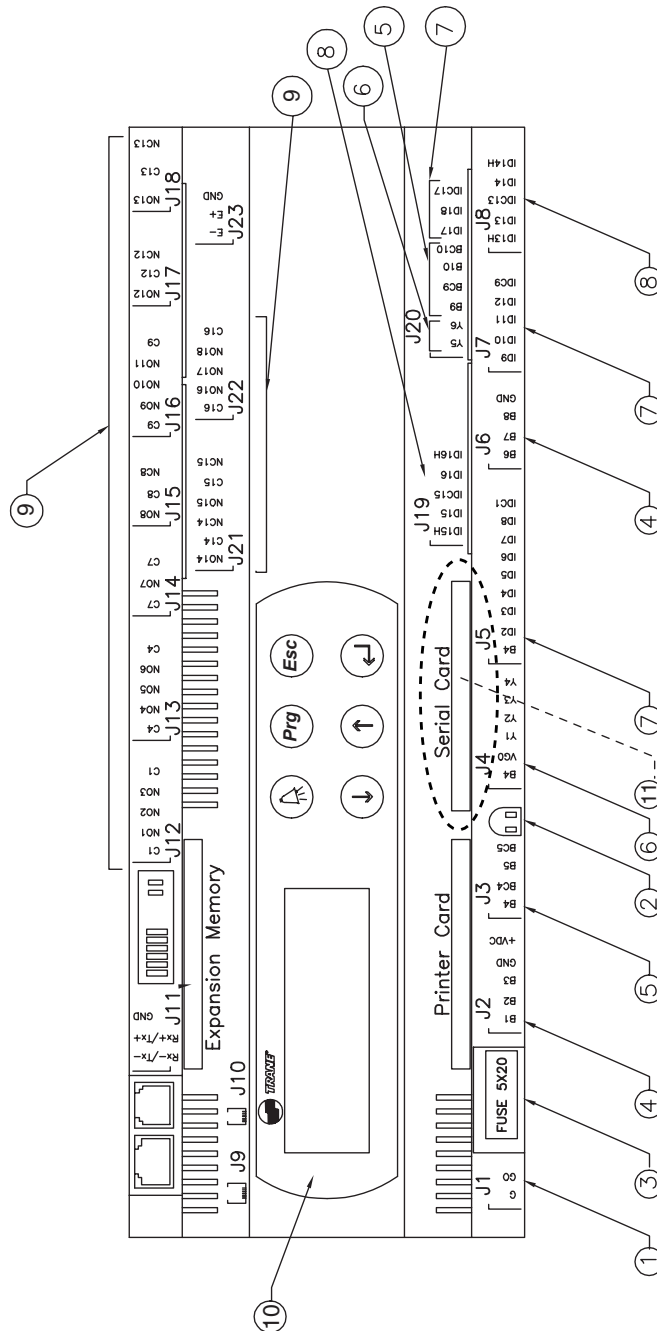

Hardware architecture

Table 1 - TRACER CH532 General description

Item	Description
1	24 V Power supply (G+,GO-)
2	Yellow LED (Power on) Red LED (Alarm)
3	Fuse (2A , 5x20)
4	Universal Analog inputs: NTC,0/1V,0/10V,0/20mA, 4/20mA)
5	Passive Analog Inputs (NTC,PT1000 , ON/OFF)
6	Analog Outputs (0/10V)
7	Digital Inputs (24Vac / Vdc)
8	Digital Inputs (230Vac or 24Vac / Vdc)
9	Relays digital output
10	User interface
11	Communication interface

Hardware architecture

Table 2 - Inputs and output summary list

	TRACER CH532 Medium Single circuit units	TRACER CH532 Large Dual circuit units
AI: Leaving water temperature sensor	B3: NTC	B3: NTC
AI: Entering water temperature sensor	B4: NTC	B4: NTC
AI: Ambient temperature sensor	B5: NTC	B5: NTC I
AI: Suction pressure circuit 1 - LP1 transducer	B1: 4..20mA	B1: 4..20mA
AI: Suction pressure circuit 2 - LP2 transducer		B6: 4..20mA
AI: Discharge pressure circuit 1 - HP1 transducer	B2: 4..20mA	B2: 4..20mA
AI: Discharge pressure circuit 2 - HP2 transducer		B7: 4..20mA
AI: External water setpoint reset (option)	B8: 0..10V-0..20mA	B8: 0..10V-0..20mA
AI: Unused	B6, B7	B9, B10
DI: Compressor C circuit 1 fault	ID1: 24Vac	ID1: 24Vac
DI: Compressor C circuit 2 fault		ID17: 24Vac
DI: Compressor A circuit 1 fault	ID3: 24Vac	ID3: 24Vac
DI: Compressor B circuit 1 fault	ID4: 24Vac	ID4: 24Vac
DI: Compressor A circuit 2 fault		ID11: 24Vac
DI: Compressor B circuit 2 fault		ID12: 24Vac
DI: High pressure Cut-out circuit 1 - HP1 switch	ID14H: 230Vac	ID14H: 230Vac
DI: High pressure Cut-out circuit 2 - HP2 switch		ID15H: 230Vac
DI: Auxiliary set point On/Off	ID8: 24Vac	ID8: 24Vac
DI: Fans circuit 1 fault	ID5: 24Vac	ID5: 24Vac
DI: Fans circuit 2 fault		ID18: 24Vac
DI: Circuit 1 On/Off (or Unit On/Off CH 532 medium)	ID13H: 230Vac	ID13H: 230Vac
DI: Circuit 2 On/Off		ID16H: 230Vac
DI: Water flow control input	ID2: 24Vac	ID2: 24Vac
DI: Water pump 1 fault	ID9: 24Vac	ID9: 24Vac
DI: Water pump 2 fault	ID10: 24Vac	ID10: 24Vac
DI: Faults external reset	ID6: 24Vac	ID6: 24Vac
DI: Cooling/Heating mode switch	ID7: 24Vac	ID7: 24Vac
DI: Unused	ID11, ID12	-
DO: Compressor A circuit 1 output	NO7: NO-230Vac	NO7: NO-230Vac
DO: Compressors B and C circuit 1 output	NO8: NO-230Vac	NO8: NO-230Vac
DO: Compressor A circuit 2 output		NO13: NO-230Vac
DO: Compressors B and C circuit 2 output		NO14: NO-230Vac
DO: Fan 1 output Wye (Y) contactor - circuit 1	NO3: NO-230Vac	NO3: NO-230Vac
DO: Fan 1 output Delta (D) contactor - circuit 1	NO4: NO-230Vac	NO4: NO-230Vac
DO: Fan 2 output circuit 1	NO5: NO-230Vac	NO5: NO-230Vac
DO: Fan 3 output circuit 1	NO6: NO-230Vac	NO6: NO-230Vac
DO: Fan 1 output Wye (Y) contactor - circuit 2		NO15: NO-230Vac
DO: Fan 1 output Delta (D) contactor - circuit 2		NO16: NO-230Vac
DO: Fan 2 output circuit 2		NO17: NO-230Vac
DO: Fan 3 output circuit 2		NO18: NO-230Vac
DO: Water pump 1	NO1: NO-230Vac	NO1: NO-230Vac
DO: Water pump 2	NO2: NO-230Vac	NO2: NO-230Vac
DO: Antifreeze heater	NC12: NO-230Vac	NC12: NO-230Vac
DO: Circuit 1 fault	NO9: NO-230Vac	NO9: NO-230Vac
DO: Circuit 2 fault		NO11: NO-230Vac
DO: Unit status or additional heating demand	NO10: NO-230Vac	NO10: NO-230Vac
DO: Unused	NO11, NO13	-
AO: Speed inverter - fan circuit 1 - HP1 output	Y1: 0..10V	Y1: 0..10V
AO: Speed inverter - fan circuit 2 - HP2 output		Y2: 0..10V
AO: 4-way valve circuit 1	Y3: 0..10V + CONVONOFF	Y3: 0..10V + CONVONOFF
AO: Unused	Y4	Y4
AO: 4-way valve circuit 2		Y5: 0..10V + CONVONOFF
AO: Unused		Y6
AO: Unused	Y2	Y2

Legend:

AI: Analog Input
 DI: Digital Input
 AO: Analog Output
 DO: Digital Output
 CONVONOFF: ON/OFF converter

Hardware architecture

TRACER CH532 offers customer the possibility to use inputs or outputs in order to:

- use an external water setpoint reset using an analog input (refer to figure 3)
- use an auxiliary setpoint
- connect a remote on/off of the unit or a circuit
- reset faults
- connect a remote Cooling/Heating switch
- return a circuit fault

Note: External water setpoint

Based on a external signal input, it will be possible to offset the active setpoint from 0°C to 20°C. This function can be used in conjunction with the automatic setpoint reset function.

Figure 3

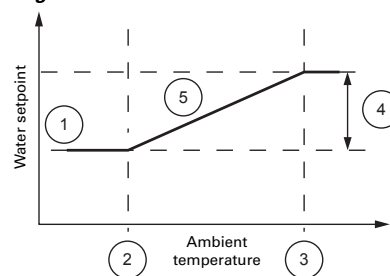

1. Leaving water temperature setpoint
2. Minimum value
3. Maximum value
4. Reset = 20°C
5. Active setpoint

Table 3: Customer Inputs and output summary list

		TRACER CH532 Medium Single circuit units	TRACER CH532 Large Dual circuit units
AI	External water setpoint reset (option)		B8: 0..10V-0..20mA
DI	Auxiliary setpoint On/Off		ID8: 24Vac
DI	Circuit 1 On/Off (or Unit On/Off for single circuit units)		ID13H: 230Vac
DI	Circuit 2 On/Off	-	ID16H: 230Vac
DI	Faults external reset		ID6: 24Vac
DI	Cooling/Heating mode switch		ID7: 24Vac
DO	Circuit 1 fault		NO9: NO-230Vac
DO	Circuit 2 fault	-	NO11: NO-230Vac
DO	Unit status or additional heating demand		NO10: NO-230Vac

Legend:
AI: Analog Input
DI: Digital Input
DO: Digital Output

Starting/stopping the unit

Once the unit is powered on (main disconnect switch closed) **TRACER CH532** returns to the following display:

TRACER CH532	V2.0
01/05/04	00:00
Water Temp	20.0°C
OFF BY KEYB.	

Note: In case of power failure unit will restart in the state (operating mode, setpoints...) it was in before the power failure and default screen will be displayed.

Line 2 gives current date and time
Line 3 gives current leaving water temperature

Line 4 gives the unit status:





OFF BY KEYB = Local stop
UNIT ON = Unit running

Pressing  from any screen will return to this screen.

1. Starting the unit:



1. Press 
2. Following screen will be displayed:

Status Unit	
OFF BY KEYB.	
Switch on unit ?	N

3. Press 
4. Press  or  to change from "N" to "Y"
5. Press . Following screen will be displayed:

TRACER CH532	V2.0
01/05/04	00:00
Water Temp	20.0°C
UNIT ON	

2. Stopping the unit

1. Press  to exit from any menu and return to default display.
2. Press  for 3 seconds unit will stop, and following screen will be displayed:

Unit Switched Off

3. Press  to return to default display

Menus

TRACER CH532 allows the user to access 4 menus to display or adjust operation parameters:

- **“Data display”** menu - This menu allows the user to visualize all operation parameters:
 - Water and air temperatures
 - Refrigerant pressures
 - Saturated refrigerant temperatures
 - Compressors status
 - Compressor running hours
 - Number of compressors starts
 - Unit operating mode
 - Compressors failures counters
- **“Settings”** menu - This menu is password protected. It allows access to the settings of:
 - Setpoints
 - Offset of cooling and heating setpoints
 - Unit operation validation
 - Customer inputs and outputs
- **“Clock”** menu - This menu is password protected. It allows access to the settings of:
 - Day of the week, hour, date
 - Daily or weekly program
 - Hourly zone program
- **“Configuration”** menu - This menu is password protected. It allows to adjust or change:
 - Unit definition
 - Compressors timers
 - High pressure control
 - Dead band, antifreeze and heater setpoints
 - Type of sensors and transducers
 - Operation protections
 - Cooling mode limitations
 - Defrost parameters
 - Compressor alarms



Accessing the menus

From any screen displayed, press

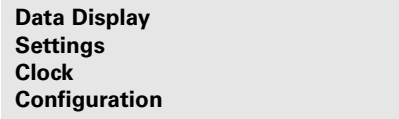
 , **TRACER CH532** will then display the following screen:





Data Display
Settings
Clock
Configuration

1.  or  allow the cursor to move from line to line thus selecting one of the 4 menus.

Note: The selection is displayed in capital characters

2. Once one line is selected,



press  to validate the choice.

3. Pressing  will exit the menu selection mode and return to default display.

Display menu: "Data display"

From the menu screen, select "Data

Display" then press 

Pressing  or  will allow navigation from screen 1 to 8 as shown hereafter:

The menu is looped making it possible to scroll from the first item in the menu to the last item.

Lvg Wat Temp	08.0°C
Ret Wat Temp	12.0°C
Amb Temp	28.0°C
Active StP	07.0°C

1. Water and air temperatures

Lvg Wat Temp = Leaving water temperature

Ret Wat Temp = Entering water temperature

Amb Temp = Ambient air temperature

Active StP = Active water setpoint

HP ckt1	00.0 bar
HP ckt2	00.0 bar
LP ckt1	00.0 bar
LP ckt2	00.0 bar

2. Refrigerant pressures

HP ckt1 = Condensing Pressure circuit 1

HP ckt2 = Condensing Pressure circuit 2 (dual circuit units only)

LP ckt1 = Evaporating Pressure circuit 1

LP ckt2 = Evaporating Pressure circuit 2 (dual circuit units only)

3. Refrigerant saturated temperatures

Sat Temp CDS1	00.0°C
Sat Temp CDS2	00.0°C
Sat Temp EVP1	00.0°C
Sat Temp EVP2	00.0°C

Sat Temp CDS1 = Condensing temperature circuit 1

Sat Temp CDS2 = Condensing temperature circuit 2 (dual circuit units only)

Sat Temp EVP1 = Evaporating temperature circuit 1

Sat Temp EVP2 = Evaporating temperature circuit 2 (dual circuit units only)

Legend for screens 4,5 and 6:

Cmp A1 = Compressor A/circuit 1

Cmp B1/C1 = Compressor B and C/circuit 1

Cmp A2 = Compressor A/circuit 2 (dual circuit units only)

Cmp B2/C2 = Compressor B and C/circuit 2 (dual circuit units only)

Cmp A1	Off
Cmp B1 C1	Off
Cmp A2	Off
Cmp B2 C2	Off

4. Compressors status

Possible Status:

Off = Compressor stopped

On = Compressor running

Rec.On = Compressor will start after anti-short cycle

Rec.Off = Compressor will stop after anti-short cycle

Cmp A1	000000 Hrs
Cmp B1 C1	000000 Hrs
Cmp A2	000000 Hrs
Cmp B2 C2	000000 Hrs

5. Compressors running time

Hrs indicates the number of full hours compressor has been working since its first start.

6. Number of compressors starts

Cmp A1	000000 Starts
Cmp B1 C1	000000 Starts
Cmp A2	000000 Starts
Cmp B2 C2	000000 Starts

Starts indicates the number of compressor starts since first start-up.

7. Operating mode

Mode	Cooling
Stp	07.0°C
Ckt1	Enable
Ckt2	Enable

Mode = Running mode

- **Cooling** = Cold water production
- **Heating** = Hot water production (Reversible chillers only)

Stp **Local** **07.0°C**

- **Stp** = Current setpoint
- **Local** = Source of Setpoint

Local = Cooling or heating setpoint defined locally

Extern = Auxiliary setpoint or operating mode by external contact

Auto = setpoint by the automatic reset or the daily/weekly program

Remote = Setpoint by supervisor

Ckt1/Ckt 2 = Operational circuits

- **Enable** = Circuit is operational
- **Disable** = Circuit is not operational

8. Compressors failures counters

Nb of CMP faults		
Cpt A1:0		Cpt A 2:0
Cpt B1:0		Cpt B 2:0
Cpt C1:0		Cpt C 2:0

This menu indicates the number of compressors failure regardless of the history.

Customer settings menu: "Settings"

From the menu screen, select "Settings" then press . Following screen will appear:

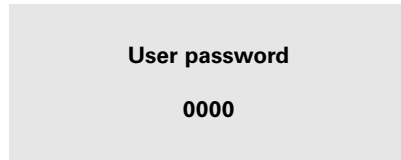

Enter password: "0000" (factory-set)

Press and cursor will move to first field of password. Pressing or will change the value from 0 to 9999. Keeping pressure on or will move the numbers fast.

Press to confirm password.

Pressing will allow navigation from screen 1 to 5 as shown hereafter:

1. Setpoints

Cooling Stp	07.0°C
Heating Stp	45.0°C
Aux Wat Stp	10.0°C
Aux Wat	Disable

To access one of the parameters displayed, press and change value using or . Confirm the value by pressing .

Cooling StP	07.0°C
Heating StP	45.0°C
Aux Wat StP	10.0°C
Aux Wat	Disable

Cooling Stp = Cold water setpoint (-12 to 20°C - factory setting: 7°C)
Heating Stp = Hot water setpoint (20 to 60°C - factory setting: 45°C)
Aux Wat Stp = Auxiliary setpoint (-12 to 60°C - factory setting: 10°C)
Aux Wat = Auxiliary setpoint from external source:
Enable = Auxiliary setpoint validated
Disable = Auxiliary setpoint non-validated

. Automatic cooling and heating mode setpoints reset

TRACER CH532 offers the possibility to offset cold and/or hot water setpoints according to ambient air temperature.

The automatic setpoint reset program will allow you to change the water temperature setpoint (cooling and heating mode) with the ambient temperature. This function can be used in conjunction with the external setpoint reset function.

Figure 4

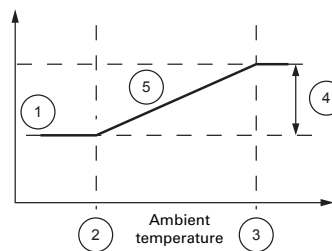

1. Leaving water temperature setpoint
2. Starting point
3. Ending point
4. Reset delta
5. Active set point

Below the reset starting point, the water temperature setpoint will be the normal setting. Between the starting and ending point the setpoint will vary proportionally with the ambient temperature. After the ending point, the setpoint will stay at its maximum or minimum value.

2.1 Cooling mode setpoint reset

To access one of the parameters displayed, press and change value using or . Confirm the value by pressing .

Cold water reset	N
Start Point	20.0°C
End Point	30.0°C
Reset Delta	10.0°C

Cold Water Reset: Ambient temperature based cold water setpoint offset

Y = Enabled

N = Disabled (factory setting)

Start Point: Starting point (-15 to 50°C - factory setting: 20°C)

End Point: Ending point (-15 to 60°C - factory setting: 30°C)

Reset Delta: Reset amplitude (-15 to 15°C - factory setting: 10°C)

3. Heating mode setpoint reset (Reversible chillers only)

To access one of the parameters displayed, press and change value using or . Confirm the value by pressing .

Hot water reset	N
Start Point	20.0°C
End Point	30.0°C
Reset Delta	10.0°C

Hot Water Reset: Ambient temperature based hot water setpoint offset

Y = Enabled

N = Disabled (Factory setting)





Start Point: Starting point (-15 to 50°C - factory setting: 20°C)

End Point: Ending point (-15 to 60°C - factory setting: 30°C)

Reset Delta: Reset amplitude (-15 to 15°C - factory setting: 10°C)

Customer settings menu: "Settings"

4. Operating mode

To access one of the parameters displayed, press  and change value using  or . Confirm the value by pressing .

Mode	Cooling
Comp seq	Auto
Ckt1	Enable
Ckt2	Enable

Mode: Operating mode

Cooling: Cold water production (default factory setting)

Heating: Hot water production (Reversible chillers only)

Extern: (external control)

Note: When switching from cooling to heating mode or from heating to cooling mode, unit will stop for 15 s before restarting.

To allow chiller waterflow rate adjustment disable circuit 1 and 2, then start the unit.

Comp seq: Compressor sequencing

1-2: fix order

Single circuit	Dual circuit	
Start order	A1,B1	A1, A2, B1, B2
Stop order	B1, A1	B2, B1, A2, A1

2-1: fix order

Single circuit	Dual circuit	
Start order	B1,A1	A2, A1, B2, B1
Stop order	A1, B1	B1, B2, A1, A2

Rotation

Single circuit	Dual circuit	
Start order	A1,B1	A1, A2, B1, B2
Stop order	A1,B1	A1, A2, B1, B2

Auto (default factory setting)

The Auto sequence intend to have equivalent numbers of starts and stops and an equivalent number of compressor working hours. The compressor start order will prioritize the compressors which have the least number of working hours.

Ckt1/2: Circuit 1/2 operation

Enable: circuit operational

Disable: circuit non-operational

Note: It is possible to disable both circuit 1 and 2. Water pump will be kept in operation

Ana. Input External setpoint reset

Y = Enabled





N = Disabled

Pump Timer: Time between unit stop (by keyboard or external contact) and stop of the pump (1 to 10 min - factory setting = 1 min)

6. Customer outputs configuration

Alarm Out:	MR only
State Out:	Unit state
Pump Timer:	01 min

5. Customer Inputs and Outputs

To access one of the parameters displayed, press  and change value using  or . Confirm the value by pressing .

Analog Input	0..10V
Ana. Input	Disable

Analog Input: Signal type
0..10V (factory setting)
0..1V
0..20mA
4..20mA

Note: the total amplitude corresponds to reset delta of +20°C between 0%(0V,0A or 4 mA) and 100% (10V,1V, or 20 mA)

Default I/O: (NO9 / NO11)

This output will be used to give an information about the circuit status: A configuration parameter will allow to choose between the following three indications concerning this circuit:

ALL: All alarms (manual and automatic reset)

ALL But LA: All alarms but without Low Ambient alarm

MR only: Manual reset alarms only (factory setting)





Status output: (NO10)

Add Heat: indicate an additional heat demand

Unit State Send data telling that at least one compressor is ON (factory setting)

Customer settings menu: "Settings"

7. Remote Mode

To access one of the parameters displayed, press  and change value using  or . Confirm the value by pressing .

Chiller control Mode:

Local
Remote

Local: Setpoints are entered on the module. Orders sent from the BMS are not taken into account.

Remote: Orders sent from the BMS are taken into account.

Clock Setting menu: "Clock"

From the menu screen, select



"Clock" then press .

Following screen will appear:

User password

0000

Enter default password: "0000" (factory set)



Press  and cursor will move to first field of password. Pressing 

or  will increment the value from

0 to 9999. Keeping pressure on 

or  will move the numbers fast.

Press  to confirm password.

Pressing  or  will allow navigation from screen 1 to 3 as shown hereafter:

1. Clock setting

To access one of the 4 parameters displayed, press  and change value

using  or .

Confirm the value by pressing .

Mon: Weekday

Clock	Mon
Hour	00:00
Date	00/00/00

Mon: Monday (factory setting)

Tue: Tuesday

Wed: Wednesday

Thu: Thursday

Fri: Friday

Sat: Saturday

Sun: Sunday

Hour: Time (hours/minutes)

Date: Date setting (day/month/year)

2. ON/OFF program type

When enabled, this program will control the unit operation (On/Off).

This program will allow the user to:

- Make a choice between the daily and/or the weekly operation
- Define the operational days and hours
- Define the operating setpoints for each mode (cooling and heating)



The operating mode selected by the operator or by the external control will be taken into account.

Example:

Time	Monday	Tuesday	Wednesday	Thursday	Friday	Saturday	
00:00							
02:00							
04:00							
06:00							
08:00	Example						
10:00	Operation enable						
12:00	▪ from Monday to Friday						
14:00	▪ from 8:00 to 18:00						
16:00							
18:00							
20:00							
22:00							

To access one of the parameters

displayed, press  and change

value using  or .

Confirm the value by pressing .

Program On/Off Unit

Weekly	N
Daily	N

Weekly: Weekly program

Y: Enabled

N: Disabled (factory setting)

Daily: Daily program

Y: Enabled

N: Disabled (factory setting)

Clock Setting menu: "Clock"

2.1 Weekly program

To access one of the parameters displayed, press and change value using or . Confirm the value pressing

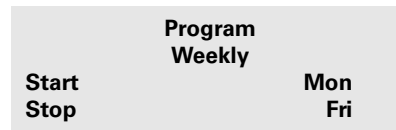

Start: Starting day
Stop: Ending day

2.2 Daily program

To access one of the parameters displayed, press and change value using or . Confirm the value by pressing

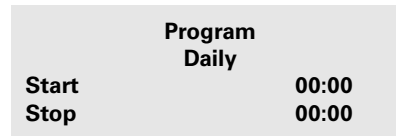

Start: Start time
Stop: Stop time

3. Hourly Zone

The Daily/weekly program will allow you to define the cooling mode and heating mode setpoints. It will be possible to define within a day, four operating zones with different setpoint as follows:
Example:

Time	Std setpoint	Zone 1	Zone 2	Zone 3	Zone 4	Setpoint	
07:00							
08:00	Operating hours 8:00-18:00					Std Stp	
09:00						Stp 1	
10:00						Stp 2	
11:00							
12:00							
13:00			Starting at 10:00				Stp 3
14:00				Starting at 11:00			
15:00					Starting at 13:00		
16:00						Starting at 16:00	Stp 4
17:00							
18:00							

Note: The automatic or external setpoint compensation or the external setpoint will change the standard setpoint only but will not affect the setpoints defined for the hourly zones 1, 2, 3 or 4.

To validate hourly zone program, press and change value using or . Confirm the value by pressing

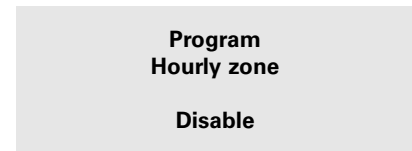

Disable: No program
Enable: Program used

3.1 Defining Zones

To access one of the parameters displayed, press and change value using or . Confirm the value by pressing

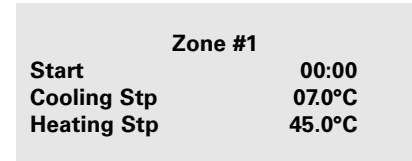

Start: Beginning Time
Cooling StP: Cooling mode setpoint (-20 to 20°C - factory setting: 7°C)
Heating StP: Heating mode setpoint - Reversible chillers only (20 to 60°C factory setting: 45°C)





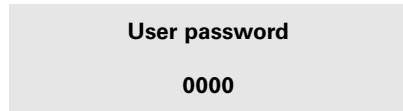

Press or to reach zones 2,3 and 4. Proceed the same way as above for programming parameters.



Unit configuration menu: "Configuration"

From the menu screen, select "Configuration" then press . Following screen will appear:







Enter default password: "0000" (factory-set)

Press  and cursor will move to first field of password. Pressing  or  will increment the value from 0 to 9999. Keeping pressure on  or  will move the numbers fast. Press  to confirm password.

Pressing  or  will allow navigation from screen 1 to 11 as shown hereafter:

1. Unit definition

To access one of the 4 parameters displayed, press  and change value using  or . Confirm the value by pressing .

Unit type:	Chiller
Refrg	R407C
Fans/ckt	3
Water pump	Single

- Unit Type:** Unit type
 - Chiller:** Cooling only
 - Heat pump:** Reversible chiller
- Refrg:** Refrigerant R407C, R134a, R410A or R22
- Fans/ckt:** Number of fans per circuit: 1, 2, or 3
- Note:** Setting number of fans at 0, will stop all the fans, but will allow the compressors to run before being stopped by HP switch.
- Water Pump:** Water pump type
 - Single:** Single pump control
 - Dual:** Dual pump control

Note: Pump operation
The water pumps can be single or dual. A timer is used to delay the pump shut down in normal operating conditions. The timer is reset at each unit start.

CG-SV01B-E4

Figure 5 - Single pump operation

Note: figures 5 to 8, Unit Off means that the unit is stopped by keyboard or by an external contact

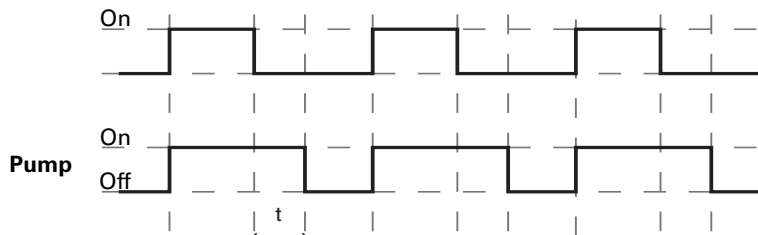
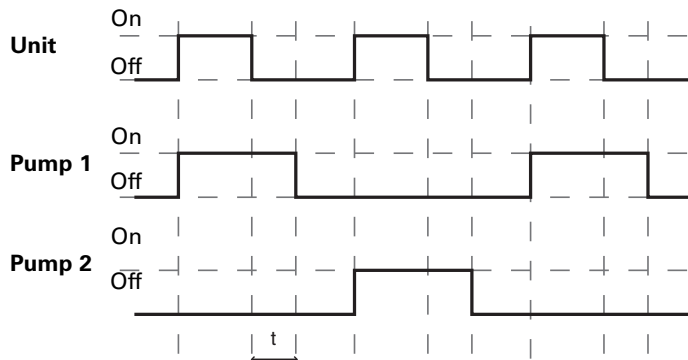
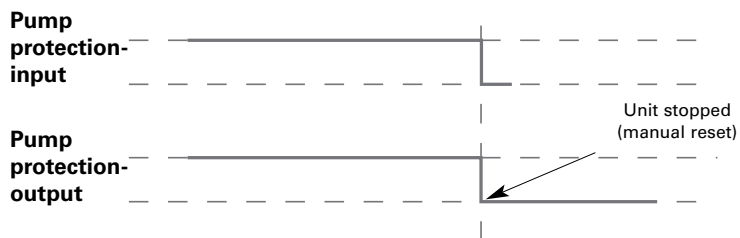

Figure 6 - Dual pump operation



When twin pumps are used, a pump switch will occur at each start and also in case of fault on the pump in operation.

Figure 7 - Single pump protection



Unit configuration menu: "Configuration"



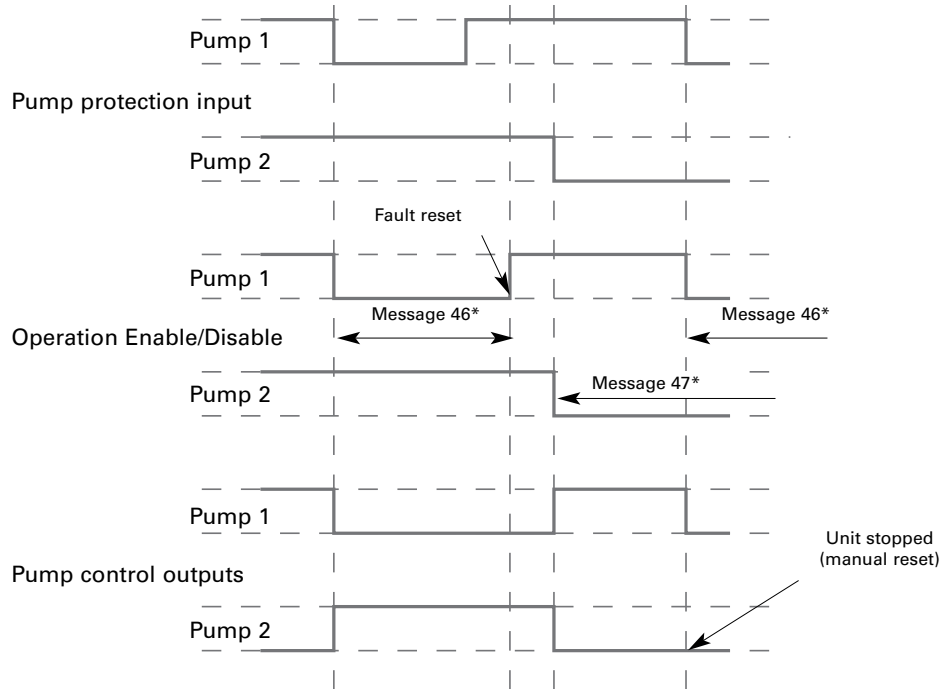

Figure 8 - Dual pump protection



* refer to "alarms" section for meaning of message

Unit configuration menu: "Configuration"

2. Compressors timers

To access one of the parameters displayed, press  and change value using  or . Confirm the value by pressing .

ACC 1st Start	2 min
ACC On-On	5 min
Min On-On	060 s
Min Off-Off	015 s





ACC 1st Start: Short cycle compressor at first start (0 to 60 min - factory setting: 2min)

ACC On-On: Short cycle between 2 starts of the same compressor (2 to 10 min - factory: 5 min)

Min On-On: Minimum time to add compressor (5 to 240 s - factory setting: 60s)

Min Off-Off: Minimum time to remove compressor (1 to 120 s factory setting 15s)

3. HP Control

To access one of the parameters displayed, press  and change value using  or . Confirm the value pressing .





Fan control	1Speed
Fan Ctrl Stp	15.0 b
Dead band Fan	06.0 b

Fan Control: Fan type:
1 speed: 1 Speed fan
2 speed: 2 Speed fan
Invert: Inverter

Fan Ctrl StP: Fan control setpoint (10 to 30 bar - factory setting: 15 bar)

Dead band Fan: Fans regulation dead band (2 to 8 bar - factory setting: 5 bar)

4. Control dead bands

To access one of the parameters displayed, press  and change value using  or . Confirm the value by pressing .

Dead band Cmp	03.0°C
Antifreeze Heater	02.0°C 03.0°C

Dead band Cmp: Compressors regulation dead band around water temperature (0.4 to 8.0°C - factory setting: 3.0°C)

AntiFreeze: Cold water temperature limit (-15 to 10°C - factory setting: 2°C)

Heater: Evaporator heater setpoint according to ambient air temperature (0 to 10°C - factory setting: 3°C)

5. Winter Freeze Protection

CW High Limit	15°C
Pmp Cycle OFF	10 min
WinFreezeProtPmp	Yes
Ctrl Pump Required	

Chilled water high limit: (15 to 25°C: factory setting 15°C)





Water pump cycle OFF: (5 to 15 min: factory setting 10min)

Winter Freeze protection with pump:

No ➔ **Heater or Ethylene Glycol Required**
Yes ➔ **Ctrl Pump Required**

Unit configuration menu: "Configuration"

6. Sensors and transducers

To access one of the parameters displayed, press  and change value using  or . Confirm the value by pressing .

Temp probe	NTC
Press probe	4..20mA
Min Press	0.0bar
Max Press	30.0bar





Temp probe: Sensor type:
NTC (factory setting)
PT100

Press probe: Pressure transducer:
0..10V
0..1V
0..20mA
4..20mA (factory setting)

Min Press: Pressure at 0V, 0mA or 4 mA (-1.0 to 0.0 bar - factory setting: 0.0 bar)

Max Press: Pressure at 10V, 1V or 20 mA (16 to 50 bar - factory setting: 30bar)

7. Operation limits

To access one of the parameters displayed, press  and change value using  or . Confirm the value by pressing .

LP (Sat Temp)	-4°C
Timer LP	60 s
HP Cool Stp	28.0 bar
HP Heat Stp	28.0 bar

LP (Sat Temp): Low evaporating pressure limit (-25 to 0°C - factory setting: -4°C)





Timer LP: Low pressure fault timer after compressor start (0 to 300 s - factory setting: 60s)

HP Cool StP: High pressure limit in cooling mode (15 to 40 bar - factory setting: 28 bar)

HP Heat StP: High pressure limit in heating mode (15 to 40 bar - factory setting: 28 bar)

8. Analog Output (for speed inverter)

Note: This screen is displayed only if "Invert" has been selected in the HP control menu (refer to §3)

To access one of the parameters displayed, press  and change value using  or . Confirm the value by pressing .

Analog output		
Low	0V	08.0 bar
High	10V	16.0 bar

Low 0V: Minimum fan speed (0 to 10 bar - factory setting: 8 bar)
High 10V: Maximum fan speed (11 to 40 bar - factory setting: 16 bar)

Unit configuration menu: "Configuration"

9. Operating limits (cooling)

Low Amb Cooling	On
Low Amb Limit	-10.0°C
CW High Limit	On
CW High Limit	15.0°C

Low ambient temperature limitation:

On: (factory setting) Low ambient limited
Off: Low ambient temperature not limited

Low ambient limit: -20 to 20°C:
factory setting -10°C

Chilled water high limitation:

On: High water temperature limited (factory setting)
Off: High water temperature not limited

Chilled water high limit: 10 to 20 °C:
Factory setting 15°C

10. Defrost demand setpoint

Low Amb Heat	-10.0°C
StP Min Temp	10.0°C
Defrost Max	12.0°C
StP Max Temp	22.0°C

Low ambient heating: -20 to 20°C,
factory setting -10°C





Setpoint at minimum ambient: 1 to 30°C,
(factory setting 10°C)

Maximum ambient: -20 to 20°C:
(factory setting 12°C)

Setpoint at maximum ambient: 1 to 30°C,
(factory setting 22°C)

11. Defrost cycle termination

To access one of the parameters

displayed, press  and change value using  or . Confirm the value by pressing .

Term Stp	20.0 bar
Drying time	12 s
Max Defrost	7 min
Min cycle	25 min

Term StP: Defrost termination setpoint (10 to 30bar - factory setting: 20 bar)

Drying time: Drying time (5 to 30 seconds - factory setting: 12s)





Max Defrost: Maximum defrost time (5 to 30 minutes - factory setting: 7 min)

Min cycle: Minimum time between defrost cycle (15 to 60min - factory setting: 25 min)

Note: Dual circuits have two independent refrigerant circuits. Defrost cycle will only occur on the circuit that needs it. The other circuit will continue its normal operation if required.

12. Compressor alarm

To access one of the parameters

displayed, press  and change value using  or . Confirm the value by pressing .

Compressor alarm	00000 h
Default parameters?	N

Compressor alarm: Operating hours for a warning (0 to 999000 hours by 1000 hours)

Setting compressor alarm at 000000 h will disable the function.

Note: Total operating hours = compressor running hours + 3 x compressor starts

Default parameters?: Set the default parameters

Y: Reset all parameters

N: Keep all parameters

Note: When resetting, all parameters programmed on site will be definitively lost. Only factory default set parameters will be kept. Full configuration of the unit will have to be checked.

Alarms

1. Alarms display and Resetting

A fault on a unit will be shown through the user interface or through 2 digital outputs, one for each refrigerant circuit.

The alarms are divided into 3 categories:

- **Warning.** Shows that something is wrong on the unit but unit can be kept in operation. A message is displayed on the user interface screen. These messages are not recorded in the history list.
- **Fault with automatic reset:** when the cause of the fault disappears, the fault is cancelled and unit operation will return to normal. The messages displayed on the user interface screen disappear but are recorded in the history list of faults. The fault is relayed through the digital output if I/O parameter is set to show a circuit fault.
- **Fault with manual reset:** when the cause of the fault disappears, a manual reset is required to restart the unit. The messages displayed on the user interface screen disappear and are recorded in the history list of faults. The fault is relayed through the digital output if I/O parameter is set to show a circuit fault.

Should an alarm occur,  will be lit in red.

Pressing  once will display the alarm message (refer to table 4 for possible messages)



When alarm message is displayed

press  to reset the default if necessary.

2. Alarms history

200 events can be recorded by TRACER CH532. Each record will give the fault description, the reset type, the order and the day and time of occurrence.

Maintaining  for 5 seconds give will access to the last event recorded.

Then using   allows the user to view the complete history. (refer to table 5 for possible messages)

Alarms

Table 4 - Status, warnings and alarm messages

No	Message	Reset Type	Unit status	Description
1	No Alarm	-	Unit On	See unit status on Main display
2	Ext. Ckt1 Stop	-	Circuit 1 Off	Circuit 1 Off by Digital Input (Dual circuit units)
3	Ext. Ckt2 Stop	-	Circuit 2 Off	Circuit 2 Off by Digital Input (Dual circuit units)
4	User Ckt1 Stop	-	Circuit 1 Off	Circuit 1 Disable by Settings (via keyboard)
5	User Ckt2 Stop	-	Circuit 2 Off	Circuit 2 Disable by Settings (via keyboard)
6	Remote Ckt1 Stop	-	Circuit 1 Off	Circuit 1 Disable by Supervision
7	Remote Ckt2 Stop	-	Circuit 2 Off	Circuit 2 Disable by Supervision
8	Clock Unit Stop	-	Unit Off	Unit Off by Program (Hourly, Weekly)
9	Operator Stop	-	Unit Off	Unit Off by Operator (via keyboard)
10	Ckt1 Defrost	-	Unit On	Circuit 1 under defrosting
11	Ckt2 Defrost	-	Unit On	Circuit 2 under defrosting
12	Warning Comp.1 Maintenance	Manual	Unit On	
13	Warning Comp.2 Maintenance	Manual	Unit On	
14	Warning Comp.3 Maintenance	Manual	Unit On	Compressor running hours above the threshold defined in unit configuration. Each compressor start is equal to 3 running hours.
15	Warning Comp.4 Maintenance	Manual	Unit On	
16	Alarm Air Sensor	Auto	Unit Off	Defective Air sensor -
17	Alarm Ckt 1 Fault	Manual	Circuit 1 Off	Simultaneous manual reset faults CMP A1 and (B1 or C1)
18	Alarm Ckt 2 Fault	Manual	Circuit 2 Off	Simultaneous manual reset faults CMP A2 and (B2 or C2)
19	Alarm Ckt1 HP Limit	Auto	Unit On	Compressor B1C1 Off for high HP ckt1
20	Alarm Ckt1 Limiting	Auto	Unit On	Compressor B1C1 Off for Hot water or low LP ckt1
21	Alarm Ckt2 HP Limit	Auto	Unit On	Compressor B2C2 Off for high HP ckt2
22	Alarm Ckt2 Limiting	Auto	Unit On	Compressor B2C2 Off for Hot water or low LP ckt2
23	Alarm Comp. A1 Fault	Auto/Manual	CMP A1 Off	Manu if CMP A1 failure > 35 min or 6 failures within 3 hours 30 min
24	Alarm Comp. B1 Fault	Auto/Manual	CMP B1 Off	Manu if CMP B1 failure > 35 min or 6 failures within 3 hours 30 min
25	Alarm Comp. C1 Fault	Auto/Manual	CMP C1 Off	Manu if CMP C1 failure > 35 min or 6 failures within 3 hours 30 min
26	Alarm Comp. A2 Fault	Auto/Manual	CMP A2 Off	Manu if CMP A2 failure > 35 min or 6 failures within 3 hours 30 min
27	Alarm Comp. B2 Fault	Auto/Manual	CMP B2 Off	Manu if CMP B2 failure > 35 min or 6 failures within 3 hours 30 min
28	Alarm Comp. C2 Fault	Auto/Manual	CMP C2 Off	Manu if CMP C2 failure > 35 min or 6 failures within 3 hours 30 min
29	Alarm Ext. Setpoint Signal	Auto	Unit Off	Defective device or bad device configuration
30	Alarm Fan Protection 1	Auto	Unit On	Defective fan on the circuit 1
31	Alarm Fan Protection 2	Auto	Unit On	Defective fan on the circuit 2
32	Alarm HP Ckt1 Fault	Manual	Circuit 1 Off	High Pressure Cut-Out circuit 1
33	Alarm HP Ckt2 Fault	Manual	Circuit 2 Off	High Pressure Cut-Out circuit 2
34	Alarm HP Sensor Ckt1	Auto	Circuit 1 Off	Defective pressure sensor HP1
35	Alarm HP Sensor Ckt2	Auto	Circuit 2 Off	Defective pressure sensor HP2
36	Alarm Low Ambient	Auto	Unit Off	Ambient temperature too low for unit operation
37	Alarm Low Water Temp	Manual	Unit Off	LWT < antifreeze or INT (antifreeze-EWT) <= 10°Cxsecond
38	Alarm LP Ckt1 Fault	Auto/Manual	Circuit 1 Off	Suction pressure too low on circuit 1
39	Alarm LP Ckt2 Fault	Auto/Manual	Circuit 2 Off	Suction pressure too low on circuit 2
40	Alarm LP Sensor Ckt1	Auto	Circuit 1 Off	Defective pressure sensor LP1
41	Alarm LP Sensor Ckt2	Auto	Circuit 2 Off	Defective pressure sensor LP2
42	Alarm Unit Fault	Manual	Unit Off	All the compressors are defectives
43	Alarm Water Flow (**)	Auto	Unit Off	No water flow. Reset by unit Off/On when pump Off
44	Alarm Water In Sensor	Auto	Unit On	Defective Return water sensor
45	Alarm Water Out Sensor	Auto	Unit Off	Defective Leaving water sensor
46	Alarm Water Pump1	Manual	Unit On	Defective water pump 1
47	Alarm Water Pump2	Manual	Unit On	Defective water pump 2

(**) When the unit is shut down after a waterflow alarm for more than 1 minute, it is necessary to switch the unit Off and On again to reset the fault. The fault will automatically reset if the water pump is still running.

Alarms

Table 5 - History events record

No	Message	Reset Type	Unit status	Description
No History		Auto	Unit On	No alarm was recorded
Air Sensor		Auto	Unit Off	Faulty sensor, out of range -30..+80°C (short circuit or open circuit)
Water In Sensor		Auto	Unit On	Faulty sensor, out of range -30..+80°C (short circuit or open circuit)
Water Out Sensor		Auto	Unit Off	Faulty sensor, out of range -30..+80°C (short circuit or open circuit)
Lp Sensor Ckt1		Auto	Circuit 1 Off	Faulty sensor, out of range 0..10V, 0..1V,0..20mA or 4..20mA following configuration
Hp Sensor Ckt1		Auto	Circuit 2 Off	Faulty sensor, out of range 0..10V, 0..1V,0..20mA or 4..20mA following configuration
Lp Sensor Ckt2		Auto	Circuit 1 Off	Faulty sensor, out of range 0..10V, 0..1V,0..20mA or 4..20mA following configuration
Hp Sensor Ckt2		Auto	Circuit 2 Off	Faulty sensor, out of range 0..10V, 0..1V,0..20mA or 4..20mA following configuration
Fan Protection 1		Auto	Unit On	A fan on the circuit 1 is faulty
Fan Protection 2		Auto	Unit On	A fan on the circuit 2 is faulty
Lp Ckt1 fault		Auto or Manual	Circuit 1 Off	Lp circuit 2 is below the setpoint. Manual reset after 3 faults within 1 hour
Lp Ckt2 fault		Auto or Manual	Circuit 2 Off	Lp circuit 1 is below the setpoint. Manual reset after 3 faults within 1 hour
Low Water Temp		Manual	Unit Off	LWT < antifreeze or INT (antifreeze-EWT)<=10°Cxsecond
Comp. A1 Fault		Auto or Manual	CMP A1 Off	Manual reset if CMP A1 failure > 35 min or 6 failures within 3 hours 30 min
Comp. B1 Fault		Auto or Manual	CMP B1 Off	Manual reset if CMP B1 failure > 35 min or 6 failures within 3 hours 30 min
Comp. C1 Fault		Auto or Manual	CMP C1 Off	Manual reset if CMP C1 failure > 35 min or 6 failures within 3 hours 30 min
Comp. A2 Fault		Auto or Manual	CMP A2 Off	Manual reset if CMP A2 failure > 35 min or 6 failures within 3 hours 30 min
Comp. B2 Fault		Auto or Manual	CMP B2 Off	Manual reset if CMP B2 failure > 35 min or 6 failures within 3 hours 30 min
Comp. C2 Fault		Auto or Manual	CMP C2 Off	Manual reset if CMP C2 failure > 35 min or 6 failures within 3 hours 30 min
Hp Ckt1 Fault		Manual	Circuit 1 Off	High pressure switch Cut-Out circuit 1
Hp Ckt2 Fault		Manual	Circuit 2 Off	High pressure switch Cut-Out circuit 2
Ckt1 Fault		Manual	Circuit 1 Off	Simultaneous faults compressor A1 and (B1 or C1)
Ckt2 Fault		Manual	Circuit 2 Off	Simultaneous faults compressor A2 and (B2 or C2)
Unit Fault		Manual	Unit Off	Simultaneous faults on all the compressors
Ext Setpoint Signal		Auto	Unit Off	Faulty sensor, out of range 0..10V, 0..1V,0..20mA or 4..20mA following configuration
Low Ambient		Auto	Unit Off	Air temperature below the setpoint while unit On
Water Pump 1		Manual	Unit On	Fault on water pump #1
Water Pump 2		Manual	Unit On	Fault on water pump #2
Water Flow		Auto	Unit Off	Loss of water flow for more than 4 sec when the system is On. Pump restarts by a manual unit Off and On
Defrost Ckt1		Auto	Unit On	Defrost on circuit 1
Defrost Ckt2		Auto	Unit On	Defrost on circuit 2

LonTalk® option

Description

The Lon interface uses an Echelon FTT-10 transceiver, which is approved to be used on the TP/FT-10 channel.

This channel is characterized by the following main features:

- It consists of up to 60 nodes on a single network segment
- Data rate : 78 125 kbps
- Maximum distance : 1400 meters
- Recommended topology : daisy chain with double end terminator (105 ohms)

For further details, refer to the official documentation LonWorks® FTT-10A free topology transceiver user's guide and to the official LonWorks® guidelines LonMark® layer 1-6 interoperability guidelines version 3.0.

These documents and additional information are available on the internet site www.lonmark.org

Figure 9

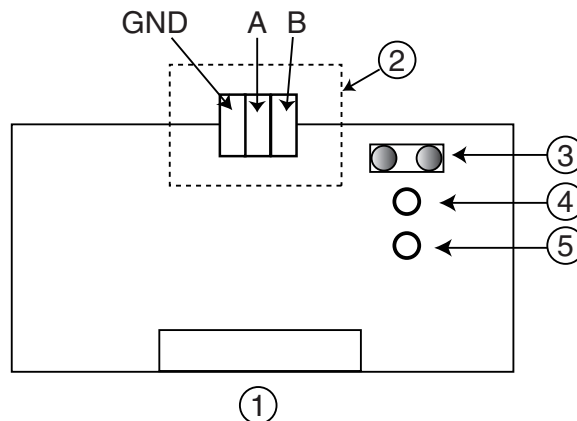

1. Connection to the Tracer CH532
2. Terminal block to the LonWorks® network (GND,A,B)
3. Service pin
4. Green status LED
5. Red service LED

To activate the service pin, simply short circuit the two pins for a moment using the tip of a screwdriver or similar tool. The service pin is available only in the node installation phase. When the pin is activated, the node sends a broadcast message in the LonWorks® containing the necessary information in order to be identified.

LonTalk® option

LED meaning and function

Green Status LED

LED status	Meaning/Function
LED is OFF continuously.	<ul style="list-style-type: none"> • Normal condition • Broken hardware • No power
LED is ON.	<ul style="list-style-type: none"> • Broken hardware • During the activation of the service pin • The node is Applicationless
LED blinks 1second then always OFF	<ul style="list-style-type: none"> • When receiving a WINK command from the network (1)
LED blinks ½ second ON then always OFF	<ul style="list-style-type: none"> • Normal operation (usually after a reset)
LED flashes once every second	<ul style="list-style-type: none"> • The node card is not configured • The node card is in continuous reset

(1) By sending a request, you can request the controller's green status LED to blink ("wink"), a notification that the controller received the signal and is communicating.

Red Service LED

LED status	Meaning/Function
LED is ON for 20 seconds when power is applied to the controller	<ul style="list-style-type: none"> • The controller is in a reset phase
LED is OFF continuously	<ul style="list-style-type: none"> • The controller is operating normally • Broken hardware
LED is ON during 2 seconds then always OFF	<ul style="list-style-type: none"> • When power is applied to the controller • After a reset
LED is ON continuously	<ul style="list-style-type: none"> • The controller is not working properly • Broken hardware • Problems of connection with the CH532 module

Object details

Figure 10

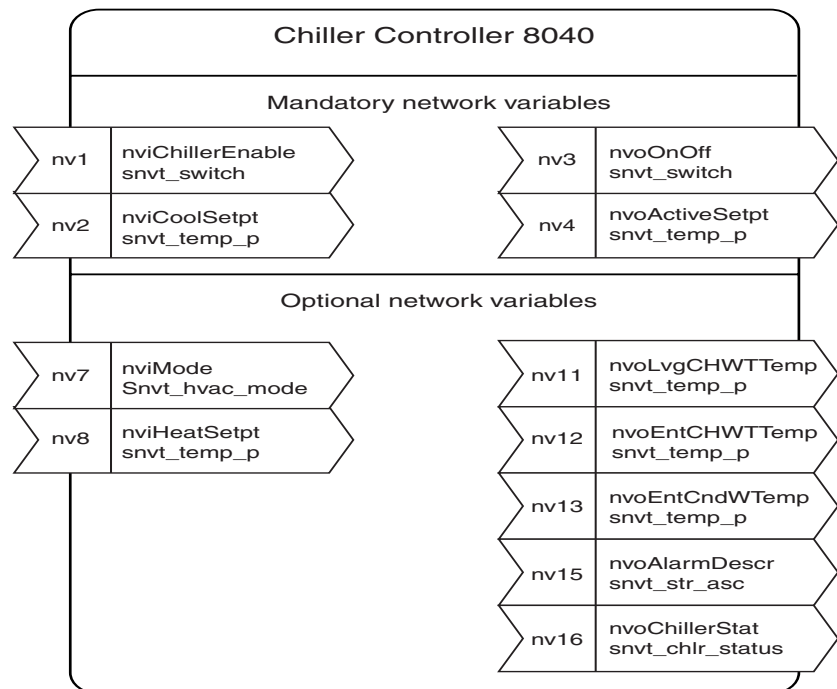

Note: BAS intergrators requiring .xif file need to contact their local sales representative.
Other optional network variables are not supported.

LonTalk® option

Nv1 0=off
1=on
nv2 range -12.2°C 48.8°C
nv3 0=chiller off
1=chiller on
nv4 range -40°C 93°C
nv7 1=heat mode
3=cooling mode
nv8 range 10°C 93°C
nv11 range -40°C 118°C
nv12 range -40°C 118°C
nv13 range -40°C 118°C
nv15 manual reset alarm
auto reset alarm
informational warning
circuit 1 fans fault
circuit 2 fans fault
compressor A1 fault
compressor B1 fault
compressor C1 fault
compressor A2 fault
compressor B2 fault
compressor C2 fault
pump 1 fault
pump 2 fault
nv16 chl_r_off=0, chl_r_run=2
HVAC_HEAT=1, HVAC_COOL=3
Chiller state 0=No alarm, 1=In alarm
Run_enable 0=Chiller not allowed to start, 1=Chiller can start
Local 0=Values can be changed remotely, 1=Values cannot be changed remotely
Limited (Not used)
CHW_flow 0=No water flow, 1=Water flow detected
CONDW_flow (Not used)
All other bits unused

Configuration properties
nc73 ChillerEnable (m)
nc52 inSendTime (m)
nc4 MaxSendTime (m)
nc7 CoolSetpt (m)
nc74 Mode (o)
nc78 HeatSetpt (o)
nc48 Heartbeat (o)

(m) = mandatory

(o) = optional

LonTalk® option

Cable characteristics

Level 4 cable may be used with TP/FT-10 channels. The level 4 cable specification used by Echelon and as originally defined by the National Electrical Manufacturers Association (NEMA) differs from the Category 4 specification proposed by the Electronic Industries Association / Telecommunication Industries Association (EIA / TIA). The following specifications can be used by cable suppliers to identify a compliant Level 4 cable.

Specifications apply to shield or unshielded 22AWG (0.65mm²) cable

D-C resistance (ohms/1000 feet at 20°C) maximum for a single copper conductor regardless of whether it is solid or stranded and is or is not metal coated	18.0
D-C resistance unbalance (percent) maximum	5
Mutual capacitance of a pair (pF/foot) maximum	17
Pair to ground capacitance unbalance (pF/1000 feet) maximum	1000
Characteristic impedance (ohms)	
772 kHz	102+/- 15%
1.0 MHz	100 +/- 15%
4.0 MHz	100 +/- 15%
8.0 MHz	100 +/- 15%
10.0 MHz	100 +/- 15%
16.0 MHz	100 +/- 15%
20.0 MHz	100 +/- 15%
Attenuation (dB/1000 feet at 20°C) maximum	
772 kHz	4.5
1.0 MHz	5.5
4.0 MHz	11
8.0 MHz	15
10.0 MHz	17
16.0 MHz	22
20.0 MHz	24

Worst pair to pair near end crosstalk (dB) minimum. Values are shown for information only. The minimum NEXT coupling loss for any pair combination at room temperature is to be greater than the value determined using the formula $NEXT (F \text{ MHz}) > NEXT (0.772) - 15 \log_{10}(F \text{ MHz} / 0.772)$ for all frequencies in the range of 0.772 MHz for a length of 1000 feet.

772 kHz	58
1.0 MHz	56
4.0 MHz	47
8.0 MHz	42
10.0 MHz	41
16.0 MHz	38
20.0 MHz	36

For the TP/FT-10 channel operating in a bus topology , the maximum bus length of level 4 22AWG (0.65 mm²) cabling is 1400 meters with a maximum stub length of 3 meters. It is recommended to use shielded cable if high amplitude modulation noise exist or transient protection is required.

Notes



Notes

Notes

Safety recommendations

To avoid accidents and damage, the following recommendations should be observed during maintenance and service visits:

1. The maximum allowable pressures for system leak testing on low and high pressure side are given in the chapter "Installation." Always provide a pressure regulator.
2. Disconnect the main supply before any servicing on the unit.
3. Service work on the refrigeration system and the electrical system should be carried out only by qualified and experienced personnel.

Maintenance contract

It is strongly recommended that you sign a maintenance contract with your local Service Agency. This contract provides regular maintenance of your installation by a specialist in our equipment. Regular maintenance ensures that any malfunction is detected and corrected in good time and minimizes the possibility that serious damage will occur. Finally, regular maintenance ensures the maximum operating life of your equipment. We would remind you that failure to respect these installation and maintenance instructions may result in immediate cancellation of the warranty.

Training

The equipment described in this manual is the result of many years of research and continuous development. To assist you in obtaining the best use of it and maintaining it in perfect operating condition over a long period of time, the manufacturer has at your disposal a refrigeration and air conditioning service school. The principal aim of this is to give operators and technicians a better knowledge of the equipment they are using, or that is under their charge. Emphasis is particularly given to the importance of periodic checks on the unit operating parameters as well as on preventive maintenance, which reduces the cost of owning the unit by avoiding serious and costly breakdown.

The manufacturer has a policy of continuous product improvement, and reserves the right to alter any details of the products at any time without notice.

This publication is a general guide to install, use and properly maintain our products. The information given may be different from the specification for a particular country or for a specific order. In this event, please refer to your nearest office.

For additional information, contact:

Distributor/Installer stamp



www.trane.com

For more information contact your local district office or e-mail us at comfort@trane.com



Quality Management
System Approval



LONMARK[®]
SPONSOR

Literature Order Number	CG-SVU01B-E4
Date	0304
Supersedes	CG-SVU01A-E4-0902
Stocking Location	Europe

Trane has a policy of continuous product and product data improvement and reserves the right to change design and specifications without notice. Only qualified technicians should perform the installation and servicing of equipment referred to in this publication.

American Standard Europe BVBA
Registered Office: 1789 Chaussée de Wavre, 1160 Brussels - Belgium