



Product Catalog

Stealth™ Air-Cooled Chillers **Model RTAE** 150 to 300 Nominal Tons



October 2014

RLC-PRC042D-EN





Introduction

Overview of Design

The Stealth™ air-cooled chiller was designed to meet the demanding requirements of today's environment. The design transforms technology into performance on which you can depend.

Trane engineers brought innovation to every component in the next-generation Trane® Stealth chiller. The result: the highest efficiency, improved system flexibility and performance, and the lowest published sound levels—all while delivering improved reliability and lower maintenance requirements.

At the core of the Stealth air-cooled chiller's performance is AdaptiSpeed™ technology—the integration of an all-new, direct-drive, specific-speed screw compressor; permanent magnet motors and the Trane third-generation Adaptive Frequency™ drive, AFD3.

AdaptiSpeed Technology

AdaptiSpeed technology delivers unmatched efficiency with some of the lowest sound levels in the industry.

- Trane third-generation Adaptive Frequency™ drive (AFD3) – The AFD3 offers a part-load efficiency improvement of more than 40 percent when compared to constant-speed chiller designs.
- Direct-drive, specific-speed screw compressor—Optimized for variable-speed operation, it delivers peak efficiency under all operating conditions.
- Variable Speed, Permanent magnet motors—The compressor's and condenser fans' permanent magnet motor design is up to 4 percent more efficient than conventional induction motors.

Copyright

This document and the information in it are the property of Trane, and may not be used or reproduced in whole or in part without written permission. Trane reserves the right to revise this publication at any time, and to make changes to its content without obligation to notify any person of such revision or change.

Trademarks

All trademarks referenced in this document are the trademarks of their respective owners.

Revision History

RLC-PRC042D-EN (07 Oct 2014). Added 150T and 165T single circuit units, extreme low ambient option, CE/PED, seismic and wind load options.

RLC-PRC042C-EN (30 May 2014). Added 200/60/3, 230/60/3 voltages. Added Transformer and Line Voltage Harmonic Filtration options. Updated weights and isolator options.

RLC-PRC042B-EN (29 Sep 2013). Added 380/50/3 configuration. Updated electrical data tables, field wiring drawing and made minor corrections.

RLC-PRC042-EN (06 Jun 2013). New catalog for RTAE product introduction.



Table of Contents

Introduction	2
Features and Benefits	5
Application Considerations	7
Model Number Description	14
General Data	16
Controls	18
Electrical	24
Electrical Connections	30
Dimensions and Weights	38
Mechanical Specifications	54
Options	57

Features and Benefits

Technology

- AdaptiSpeed™ technology assures optimal performance at all operating conditions
 - Permanent magnet motor - up to 4% more efficient than an induction motor
 - AFD3 Adaptive Frequency™ Drive
 - Soft start provided as standard to reduce power in-rush at start-up
 - One of the first true 24 pulse drive systems in the industry
 - Compressor design optimized for variable speed operation
 - Rotor profile designed for maximum efficiency at higher speeds
- Shuttle valve enhances compressor oil management
- Variable speed permanent magnet motors on ALL condenser fans for increased efficiency and lower sound
- Larger diameter condenser fans operate at lower speed with optimized blade design
- Compact, high-efficiency, integrated low refrigerant charge evaporator design
- Integral compressor muffler lowers sound levels by 4-10 dB compared to previous design
- Optional metallic discharge and suction bellows reduce compressor sound by 8-10 dB

Cost of Ownership

- Industry-leading efficiency
 - Over 20% higher full load efficiency than ASHRAE 90.1-2010
 - Minimizing kW demand and infrastructure
 - Over 40% higher part load efficiency than ASHRAE 90.1-2010
 - Minimize kW usage
- Drive designed to last the life of the chiller
- High power factor at all load points reducing the need for power factor correction capacitors
- Variable speed drives on all condenser fans save energy at part load operation, as well as lower sound levels even further as fan speeds are reduced during part load operation.
- Transverse modular coil design for easy access for coil cleaning
- Up to 40% lower refrigerant charge compared to previous evaporator designs
- Factory-engineered, tested and installed sound control options reduce jobsite time and cost
- Three levels of sound reduction available to meet various job site acoustical requirements



Features and Benefits

Reliability

- Robust drive design using film capacitors for longer drive life
- Industrial bearing system designed for the life of the chiller
- Shuttle valve reduces the differential oil pressure required for cold weather start-up
- New header design eliminates brazed coil u-bends, significantly reduces potential for refrigerant leaks
- All aluminum alloy coils reduce potential for corrosion
- Enhanced factory-applied corrosion protection available
- Rapid Restart capability minimizes downtime
- Easy hookup to Uninterruptable Power Supply (UPS) for mission critical applications

Precision Control

- New 7 inch color touch screen display with graphics
- Powered by UC800 industry-leading control algorithms
 - Enhanced flow management provides unmatched system performance in variable flow water systems
- Adaptive Control™ keeps the chiller running in extreme conditions
 - Tight set point control
 - Graphical trending
 - Maximized chiller update
- BACnet®, Modbus™, LonTalk®, communications protocol interface available without the need for gateways
- Optional condenser fan speed control to help meet preset nighttime sound requirements

Application Considerations

Certain application constraints should be considered when sizing, selecting and installing Trane RTAE chillers. Unit and system reliability is often dependent upon proper and complete compliance with these considerations. Where the application varies from the guidelines presented, it should be reviewed with your local Trane account manager.

Note: *The terms water and solution are used interchangeably in the following paragraphs.*

Water Treatment

The use of untreated or improperly treated water in chillers may result in scaling, erosion, corrosion, and algae or slime buildup. This will adversely affect heat transfer between the water and system components. Proper water treatment must be determined locally and depends on the type of system and local water characteristics.

Neither salt nor brackish water is recommend for use in Trane air-cooled RTAE chillers. Use of either will lead to a shortened life. Trane encourages the employment of a qualified water treatment specialist, familiar with local water conditions, to assist in the establishment of a proper water treatment program.

Foreign matter in the chilled water system can also increase pressure drop and, consequently, reduce water flow.

For this reason it is important to thoroughly flush all water piping to the unit before making the final piping connections to the unit.

The capacities given in the Performance Data section of this catalog are based on water with a fouling factor of 0.0001°F·ft²·h/Btu (in accordance with AHRI 550/590). For capacities at other fouling factors, see Performance Selection Software.

Effect of Altitude on Capacity

At elevations substantially above sea level, the decreased air density will decrease condenser capacity and, therefore, unit capacity and efficiency.

Ambient Limitations

Trane chillers are designed for year-round operation over a range of ambient temperatures. The air-cooled model RTAE chiller will operate in ambient temperatures of:

- Standard Ambient Range = 32 to 105°F (0 to 40.6°C)
- Low Ambient Range = 0 to 105°F (-17.7 to 40.6°C)
- Extreme Low Ambient Range = -20 to 105°F (-28.9 to 40.6°C)
- High Ambient Range = 32 to 125°F (0 to 52°C)
- Wide Ambient Range = 0 to 125°F (-17.7 to 52°C)

The minimum ambient temperatures are based on still conditions (winds not exceeding five mph). Greater wind speeds will result in a drop in head pressure, therefore increasing the minimum starting and operating ambient temperature. The Adaptive Frequency™ microprocessor will attempt to keep the chiller on-line when high or low ambient conditions exist, making every effort to avoid nuisance trip-outs and provide the maximum allowable tonnage.

Water Flow Limits

The minimum water flow rates are given in the chapter “General Data,” p. 16 of this catalog. Evaporator flow rates below the tabulated values will result in laminar flow causing freeze-up problems, scaling, stratification and poor control. The maximum evaporator water flow rate is also given. Flow rates exceeding those listed may result in very high pressure drop across the evaporator and/or evaporator tube erosion.

Flow Rates Out of Range

Many process cooling jobs require flow rates that cannot be met with the minimum and maximum published values within the RTAE evaporator. A simple piping change can alleviate this problem. For example: a plastic injection molding process requires 80 gpm (5.0 l/s) of 50°F (10°C) water and returns that water at 60°F (15.6°C). The selected chiller can operate at these temperatures, but has a minimum flow rate of 106 gpm (6.6 l/s). The system layout in [Figure 1](#) can satisfy the process.

Figure 1. Flow rate out of range systems solution

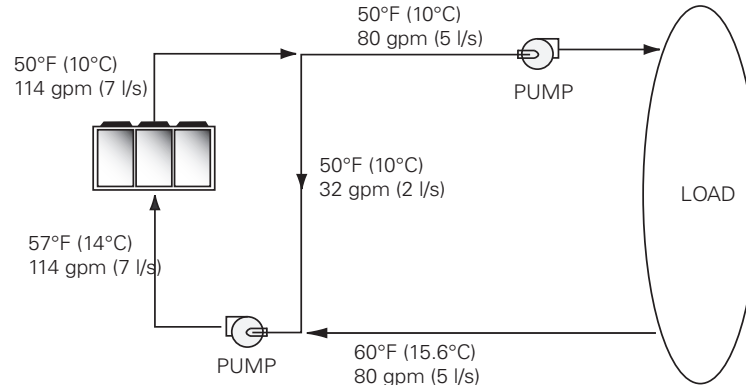

Flow Proving

Trane provides a factory-installed water flow switch monitored by UC800 which protects the chiller from operating in loss of flow conditions.

Water Temperature

Leaving Water Temperature Limits

Trane RTAE chillers have three distinct leaving water categories:

- Standard, with a leaving solution range of 40 to 68°F (4.4 to 20°C)
- Low temperature process cooling, with leaving solution less than 40°F (4.4°C)
- Ice-making, with a leaving solution range of 20 to 68°F (-6.7 to 20°C)

Since leaving solution temperatures below 40°F (4.4°C) result in suction temperature at or below the freezing point of water, a glycol solution is required for all low temperature and ice-making machines. Ice making control includes dual setpoints and safeties for ice making and standard cooling capabilities. Consult your local Trane account manager for applications or selections involving low temperature or ice making machines.

The maximum water temperature that can be circulated through the RTAE evaporator when the unit is not operating is 125°F (52°C). Evaporator damage may result above this temperature.

Leaving Water Temperature Out of Range

Many process cooling jobs require temperature ranges that are outside the allowable minimum and maximum operating values for the chiller. [Figure 2](#) below shows a simple example of a mixed water piping arrangement change that can permit reliable chiller operation while meeting such cooling conditions. For example, a laboratory load requires 238 gpm (15 l/s) of water entering the process at 86°F (30°C) and returning at 95°F (35°C). The chiller's maximum leaving chilled water temperature of 68°F (20°C) prevents direct supply to the load. In the example shown, both the chiller and process flow rates are equal, however, this is not necessary. For example, if the chiller had a higher flow rate, there would simply be more water bypassing and mixing with warm water returning to the chiller.

Figure 2. Temperature out of range system solution

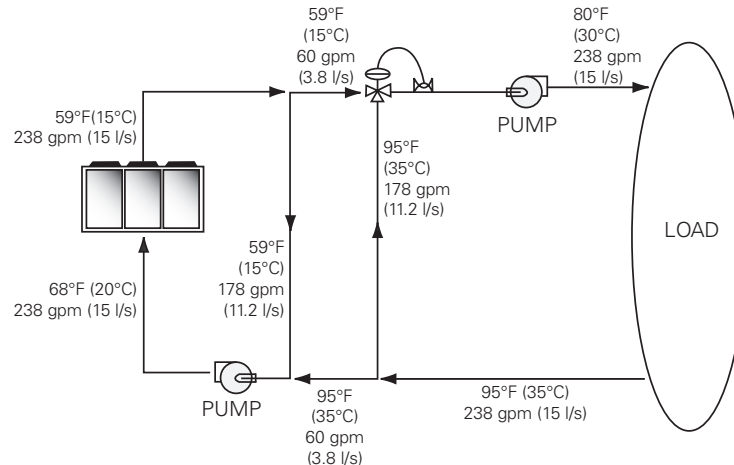

Variable Flow in the Evaporator

An attractive chilled water system option may be a variable primary flow (VPF) system. VPF systems present building owners with several cost saving benefits that are directly related to the pumps. The most obvious cost savings result from eliminating the secondary distribution pump, which in turn avoids the expense incurred with the associated piping connections (material, labor), electrical service, and variable frequency drive. Building owners often cite pump related energy savings as the reason that prompted them to install a VPF system.

The evaporator on the Stealth can withstand up to 50 percent water flow reduction as long as this flow is equal to or above the minimum flow rate requirements. The microprocessor and capacity control algorithms are designed to handle a maximum of 10% change in water flow rate per minute in order to maintain $\pm 0.5^\circ\text{F}$ (0.28°C) leaving evaporator temperature control. For applications in which system energy savings is most important and tight temperature control is classified as $\pm 2^\circ\text{F}$ (1.1°C), up to 30 percent changes in flow per minute are possible.

With the help of a software analysis tool such as System Analyzer™, DOE-2 or TRACE™, you can determine whether the anticipated energy savings justify the use of variable primary flow in a particular application. It may also be easier to apply variable primary flow in an existing chilled water plant. Unlike the "decoupled" system design, the bypass can be positioned at various points in the chilled water loop and an additional pump is unnecessary.

Series Chiller Arrangements

Another energy saving strategy is to design the system around chillers arranged in series. The actual savings possible with such strategies depends on the application dynamics and should be researched by consulting your Trane Systems Solutions Representative and applying an analysis tool from the Trace software family. It is possible to operate a pair of chillers more efficiently in a series chiller arrangement than in a parallel arrangement. It is also possible to achieve higher entering to leaving chiller differentials, which may, in turn, provide the opportunity for lower chilled water design temperature, lower design flow, and resulting installation and operational cost savings. The Trane screw compressor also has excellent capabilities for "lift," which affords an opportunity for "lift," which affords an opportunity for savings on the evaporator water loop.

Series chiller arrangements can be controlled in several ways. [Figure 3, p. 10](#) shows a strategy where each chiller is trying to achieve the system design set point. If the cooling load is less than 50 percent of the systems capabilities, either chiller can fulfill the demand. As system loads increase, the Chiller 2 becomes preferentially loaded as it attempts to meet the leaving chilled water

Application Considerations

setpoint. Chiller 1 will finish cooling the leaving water from Chiller 2 down to the system design setpoint.

Staggering the chiller set points is another control technique that works well for preferentially loading Chiller 1. If the cooling load is less than 50 percent of the system capacity, Chiller 1 would be able to satisfy the entire call for cooling. As system loads increase, Chiller 2 is started to meet any portion of the load that Chiller 1 can not meet.

Figure 3. Typical series chiller arrangement

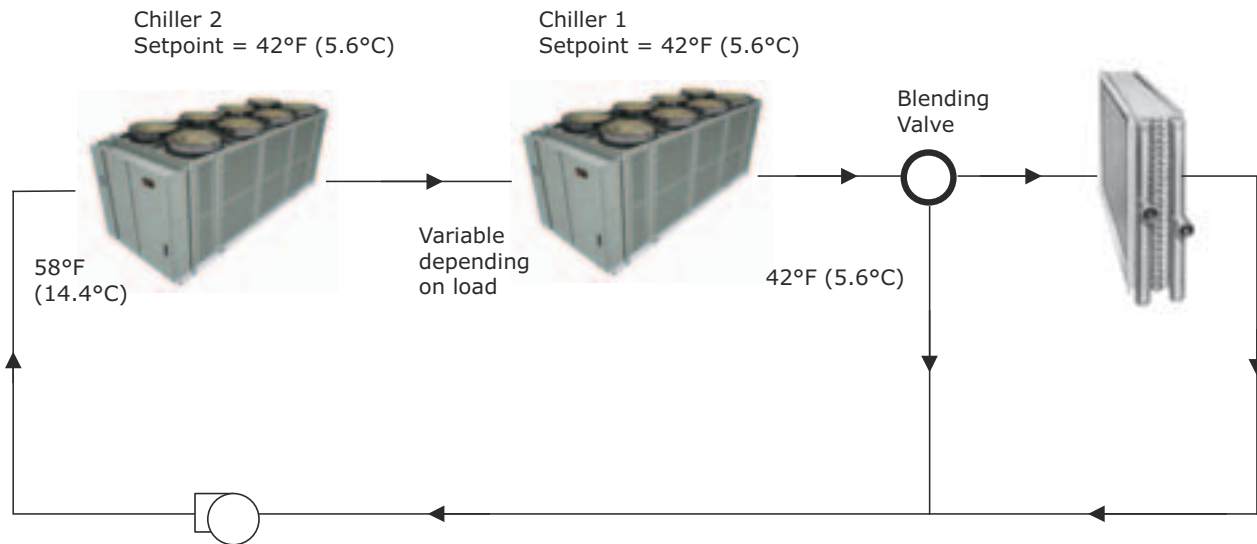

Typical Water Piping

All building water piping must be flushed prior to making final connections to the chiller. To reduce heat loss and prevent condensation, insulation should be applied. Expansion tanks are also usually required so that chilled water volume changes can be accommodated.

Avoidance of Short Water Loops

Adequate chilled water system water volume is an important system design parameter because it provides for stable chilled water temperature control and helps limit unacceptable short cycling of chiller compressors.

The chiller's temperature control sensor is located in the waterbox. This location allows the building to act as a buffer to slow the rate of change of the system water temperature. If there is not a sufficient volume of water in the system to provide an adequate buffer, temperature control can suffer, resulting in erratic system operation and excessive compressor cycling.

Typically, a two-minute water loop circulation time is sufficient to prevent short water loop issues. Therefore, as a guideline, ensure the volume of water in the chilled water loop equals or exceeds two times the evaporator flow rate. For systems with a rapidly changing load profile the amount of volume should be increased.

If the installed system volume does not meet the above recommendations, the following items should be given careful consideration to increase the volume of water in the system and, therefore, reduce the rate of change of the return water temperature.

- A volume buffer tank located in the return water piping.

- Larger system supply and return header piping (which also reduces system pressure drop and pump energy use).

Minimum water volume for a process application

If a chiller is attached to an on/off load such as a process load, it may be difficult for the controller to respond quickly enough to the very rapid change in return solution temperature if the system has only the minimum water volume recommended. Such systems may cause chiller low temperature safety trips or in the extreme case evaporator freezing. In this case, it may be necessary to add or increase the size of the mixing tank in the return line.

Multiple Unit Operation

Whenever two or more units are used on one chilled water loop, Trane recommends that their operation be coordinated with a higher level system controller for optimum system efficiency and reliability. The Trane Tracer system has advanced chilled plant control capabilities designed to provide such operation.

Ice Storage Operation

An ice storage system uses the chiller to make ice at night when utilities generate electricity more efficiently with lower demand and energy charges. The stored ice reduces or even replaces mechanical cooling during the day when utility rates are at their highest. This reduced need for cooling results in significant utility cost savings and source energy savings.

Another advantage of an ice storage system is its ability to eliminate chiller over sizing. A “rightsized” chiller plant with ice storage operates more efficiently with smaller support equipment while lowering the connected load and reducing operating costs. Best of all this system still provides a capacity safety factor and redundancy by building it into the ice storage capacity for practically no cost compared to over sized systems.

The Trane air-cooled chiller is uniquely suited to low temperature applications like ice storage because of the ambient relief experienced at night. Chiller ice making efficiencies are typically similar to or even better than standard cooling daytime efficiencies as a result of night-time dry-bulb ambient relief.

Standard smart control strategies for ice storage systems are another advantage of the RTAE chiller. The dual mode control functionality is integrated right into the chiller. Trane Tracer building management systems can measure demand and receive pricing signals from the utility and decide when to use the stored cooling and when to use the chiller.

Unit Placement

Setting The Unit

A base or foundation is not required if the selected unit location is level and strong enough to support the unit’s operating weight. (See “Weights,” p. 38.)

For a detailed discussion of base and foundation construction, see the sound engineering bulletin or the unit IOM. Manuals are available through online product portal pages or from your local office.

HVAC equipment must be located to minimize sound and vibration transmission to the occupied spaces of the building structure it serves. If the equipment must be located in close proximity to a building, it should be placed next to an unoccupied space such as a storage room, mechanical room, etc. It is not recommended to locate the equipment near occupied, sound sensitive areas of the building or near windows. Locating the equipment away from structures will also prevent sound reflection, which can increase sound levels at property lines or other sensitive points.

Isolation and Sound Emission

Structurally transmitted sound can be reduced by elastomeric vibration eliminators. Elastomeric isolators are generally effective in reducing vibratory noise generated by compressors, and

Application Considerations

therefore, are recommended for sound sensitive installations. An acoustical engineer should always be consulted on critical applications.

Figure 4. Installation example

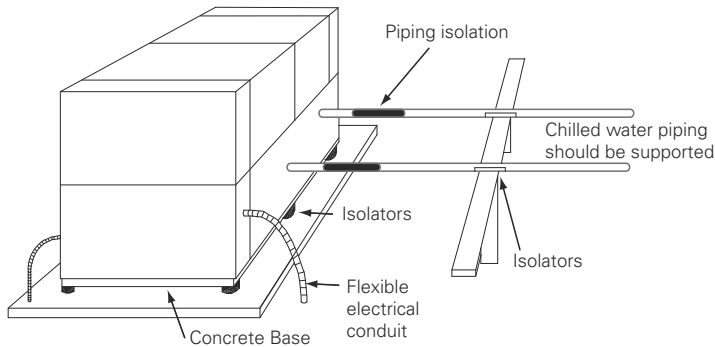

For maximum isolation effect, water lines and electrical conduit should also be isolated. Wall sleeves and rubber isolated piping hangers can be used to reduce sound transmitted through water piping. To reduce the sound transmitted through electrical conduit, use flexible electrical conduit.

Local codes on sound emissions should always be considered. Since the environment in which a sound source is located affects sound pressure, unit placement must be carefully evaluated. Sound power levels for chillers are available on request.

Servicing

Adequate clearance for evaporator, condenser and compressor servicing should be provided. Recommended minimum space envelopes for servicing are located in the dimensional data section and can serve as a guideline for providing adequate clearance. The minimum space envelopes also allow for control panel door swing and routine maintenance requirements. Local code requirements may take precedence.

Unit Location

General

Unobstructed flow of condenser air is essential to maintain chiller capacity and operating efficiency. When determining unit placement, careful consideration must be given to assure a sufficient flow of air across the condenser heat transfer surface. Two detrimental conditions are possible and must be avoided: warm air recirculation and coil starvation. Air recirculation occurs when discharge air from the condenser fans is recycled back to the condenser coil inlet. Coil starvation occurs when free airflow to the condenser is restricted.

Condenser coils and fan discharge must be kept free of snow or other obstructions to permit adequate airflow for satisfactory unit operation. Debris, trash, supplies, etc., should not be allowed to accumulate in the vicinity of the air-cooled chiller. Supply air movement may draw debris into the condenser coil, blocking spaces between coil fins and causing coil starvation.

Both warm air recirculation and coil starvation cause reductions in unit efficiency and capacity due to higher head pressures. The air-cooled RTAE chiller offers an advantage over competitive equipment in these situations. Operation is minimally affected in many restricted air flow situations due to its advanced Adaptive Control™ microprocessor which has the ability to understand the operating environment of the chiller and adapt to it by first optimizing its performance and then staying on line through abnormal conditions. For example, high ambient temperatures combined with a restricted air flow situation will generally not cause the air-cooled model RTAE chiller to shut down. Other chillers would typically shut down on a high pressure nuisance cut-out in these conditions.

Cross winds, those perpendicular to the condenser, tend to aid efficient operation in warmer ambient conditions. However, they tend to be detrimental to operation in lower ambients due to the accompanying loss of adequate head pressure. Special consideration should be given to low ambient units. As a result, it is advisable to protect air-cooled chillers from continuous direct winds exceeding 10 mph (4.5 m/s) in low ambient conditions.

The recommended lateral clearances are depicted in the Close-Spacing and Restricted Airflow Engineering Bulletin RLC-PRB037*-EN available on product portal pages or from your local office.

Provide Sufficient Unit-to-Unit Clearance

Units should be separated from each other by sufficient distance to prevent warm air recirculation or coil starvation. Doubling the recommended single unit air-cooled chiller clearances will generally prove to be adequate. See Close-Spacing and Restricted Airflow Engineering Bulletin RLC-PRB037*-EN for more information.

Walled Enclosure Installations

When the unit is placed in an enclosure or small depression, the top of the surrounding walls should be no higher than the top of the fans. The chiller should be completely open above the fan deck. There should be no roof or structure covering the top of the chiller. Ducting individual fans is not recommended. See Close-Spacing and Restricted Airflow Engineering Bulletin RLC-PRB037*-EN for more information.



Model Number Description

Digits 1,2 – Unit Model

RT = Rotary Chiller

Digits 3 – Unit Type

A = Air-cooled

Digits 4 – Development Sequence

E = Development Sequence

Digits 5-7 – Nominal Capacity

149 = 150 Nominal Tons Single Circuit
164 = 165 Nominal Tons Single Circuit
150 = 150 Nominal Tons
165 = 165 Nominal Tons
180 = 180 Nominal Tons
200 = 200 Nominal Tons
225 = 225 Nominal Tons
250 = 250 Nominal Tons
275 = 275 Nominal Tons
300 = 300 Nominal Tons

Digit 8 – Unit Voltage

A = 200/60/3
B = 230/60/3
C = 380/50/3
D = 380/60/3
E = 400/50/3
F = 460/60/3
G = 575/60/3
H = 400/60/3

Digit 9 – Manufacturing Location

U = Trane Commercial Systems, Pueblo, CO USA

Digits 10, 11 – Design Sequence

XX = Factory assigned

Digit 12 – Unit Sound Package

1 = InvisiSound™ Standard Unit
2 = InvisiSound Superior (Line Wraps, Reduced Fan Speed)
3 = InvisiSound Ultimate (Compressor Sound Attenuation, Line Wraps, Reduced Fan Speed)

Digit 13 – Agency Listing

0 = No Agency Listing
A = UL/CUL Listing
C = CE European Safety Standard

Digit 14 – Pressure Vessel Code

A = ASME Pressure Vessel Code
D = Australia Pressure Vessel Code
C = CRN or Canada Equivalent Pressure Vessel Code
L = Chinese Pressure Vessel Code
P = PED European Pressure Vessel Code

Digit 15 – Factory Charge

1 = Refrigerant Charge HFC-134a
2 = Nitrogen Charge

Digit 16 – Evaporator Application

F = Standard Cooling (40 to 68°F/5.5 to 20°C)
G = Low Temp Process (<40°F Leaving Temp)
C = Ice-making (20 to 68°F/-7 to 20°C) w/ Hardwired Interface

Digit 17 – Evaporator Configuration

N = 2 Pass Evaporator
P = 3 Pass Evaporator

Digit 18 – Evaporator Fluid Type

1 = Water
2 = Calcium Chloride
3 = Ethylene Glycol
4 = Propylene Glycol
5 = Methanol

Digit 19 – Water Connection

X = Grooved Pipe
F = Grooved Pipe + Flange

Digit 20 – Flow Switch

1 = Factory Installed - Other Fluid (15 cm/s)
2 = Factory Installed - Water 2 (35 cm/s)
3 = Factory Installed - Water 3 (45 cm/s)

Digit 21 – Insulation

A = Factory Insulation - All Cold Parts 0.75"
B = Evaporator-Only Insulation - High Humidity/Low Evap Temp 1.25"

Digit 22 – Unit Application

1 = Standard Ambient (32 to 105°F/0 to 40.6°C)
2 = Low Ambient (0 to 105°F/-17.7 to 40.6°C)
3 = Extreme Low Ambient (-20 to 105°F/-28.9 to 40.6°C)
4 = High Ambient (32 to 125°F/0 to 52°C)
5 = Wide Ambient (0 to 125°F/-17.7 to 52°C)

Digit 23 – Condenser Fin Options

A = Aluminum Fins with Slits
D = CompleteCoat™ Epoxy Coated Fins

Digits 24, 25 – Not Used

Digit 26 – Power Line Connection Type

A = Terminal Block
C = Circuit Breaker
D = Circuit Breaker w/ High Fault Rated Control Panel

Digit 27 – Short Circuit Current Rating

A = Default A Short Circuit Rating
B = High A Short Circuit Rating

Digit 28 – Transformer

0 = No Transformer
1 = Factory Installed Transformer

Digit 29 – Line Voltage Harmonic Mitigation

X = Line Reactors (~30% TDD)
1 = Filter circuit (IEEE519 Compliant)

Digit 30 – Electrical Accessories

0 = No Convenience Outlet
C = 15A 115V convenience Outlet (Type B)

Digit 31 – Remote Communication Options

0 = No Remote Digital Communication
1 = LonTalk® Interface LCI-C (Tracer™ Compatible)
2 = BACnet® MS/TP Interface (Tracer compatible)
3 = ModBus™ Interface

Digit 32 – Hard Wire Communication

X = None
A = Hard Wired Bundle - All
B = Remote Leaving Water Temp Setpoint
C = Remote Leaving temp and Demand Limit Setpoints
D = Programmable Relay
E = Programmable Relay and Leaving Water and Demand Limit Setpoint
F = Percent Capacity
G = Percent Capacity and Leaving Water and Demand Limit Setpoint
H = Percent Capacity and Programmable Relay

Digit 33 – Not Used

Digit 34 – Structural Options

- A = Standard Unit Structure
- B = Seismic to International Building Code (IBC)
- C = California Office of Statewide Health Planning and Development (OSHPD) Certification
- D = Wind Load for Florida Hurricane 175 MPH
- E = Seismic (IBC) and Wind Load
- F = OSHPD and Wind Load

Digit 35 – Appearance Options

- 0 = No Appearance Options
- A = Architectural Louvered Panels

Digit 36 – Unit Isolation

- 0 = No Isolation
- 1 = Elastomeric Isolators
- 3 = Seismic Rated Isopads

Digit 37 – Not Used

- 0 = Not Used

Digit 38 – Not Used

- 0 = Not Used

Digit 39 – Special

- 0 = None
- S = Special



General Data

Table 1. General data table

Unit Size (tons)		150	165	180	200	225	250	275	300	150SC	165SC
Compressor Model		CHHSR	CHHSR	CHHSR	CHHSR	CHHSS	CHHSS	CHHSS	CHHSS	CHHSS	CHHSS
Quantity	#	2	2	2	2	2	2	2	2	1	1
Evaporator											
Water Storage	(gal)	17.5	18.7	21.9	23.9	26.6	28.7	33.0	36.0	17.3	17.3
	(L)	66.1	70.9	82.8	90.5	100.6	108.8	125.0	136.1	65.6	65.6
2 Pass arrangement											
Minimum Flow	(gpm)	171	187	202	228	261	288	318	354	169	169
	(l/s)	10.8	11.8	12.7	14.4	16.5	18.2	20.1	22.3	10.7	10.7
Maximum Flow	(gpm)	626	684	742	835	957	1055	1165	1299	620	620
	(l/s)	39.5	43.1	46.8	52.7	60.4	66.5	73.5	81.9	39.1	39.1
3 Pass arrangement											
Minimum Flow	(gpm)	114	124	135	152	174	192	212	236	113	113
	(l/s)	7.2	7.8	8.5	9.6	11.0	12.1	13.4	14.9	7.1	7.1
Maximum Flow	(gpm)	417	456	495	557	638	703	777	866	414	414
	(l/s)	26.3	28.8	31.2	35.1	40.2	44.3	49.0	54.6	26.1	26.1
Condenser											
Qty of Coils		8	10	10	12	12	12	14	16	8	10
Coil Length	(in)	78.74	78.74	78.74	78.74	78.74	78.74	78.74	78.74	78.74	78.74
	(mm)	2000	2000	2000	2000	2000	2000	2000	2000	2000	2000
Coil Height	(in)	50	50	50	50	50	50	50	50	50	50
	(mm)	1270	1270	1270	1270	1270	1270	1270	1270	1270	1270
Fins/Ft		192	192	192	192	192	192	192	192	192	192
Rows		3	3	3	3	3	3	3	3	3	3
Condenser Fans											
Quantity	#	8	10	10	12	12	12	14	16	8	10
Diameter	(in)	37.5	37.5	37.5	37.5	37.5	37.5	37.5	37.5	37.5	37.5
	(mm)	953	953	953	953	953	953	953	953	953	953
Total Airflow	(cfm)	107,392	134,240	134,240	161,088	161,088	161,088	187,936	214,784	107,392	132,240
	(m3/hr)	182,460	228,075	228,075	273,690	273,690	273,690	319,305	364,920	182,460	228,075
Tip Speed	(ft/min)	8700	8700	8700	8700	8700	8700	8700	8700	8700	8700
	(M/S)	44.2	44.2	44.2	44.2	44.2	44.2	44.2	44.2	44.2	44.2
Ambient Temperature Range											
Standard Ambient	°F (°C)	32 to 105 (0 to 40.6)									
Low Ambient	°F (°C)	0 to 105 (-17.7 to 40.6)									
Extreme Low Ambient	°F (°C)	-20 to 105 (-28.9 to 40.6)									
High Ambient	°F (°C)	32 to 125 (0 to 52)									
Wide Ambient	°F (°C)	0 to 125 (-17.7 to 52)									
General Unit											
Refrigerant		HFC-134a									
Refrigerant Ckts	#	2									
Minimum Load	%	20	18	17	15	20	18	16	15	30	27
Refrigerant Charge/ckt	(lbs)	172	181	210	218	265	261	318	325	322	346
	(kg)	78	82	95	99	120	118	144	148	146	157
Oil		Trane OIL00311									
Oil Charge/ckt	(gal)	3.0	3.0	3.0	3.0	4.0	4.0	4.0	4.0	4.0	4.0
	(L)	11.4	11.4	11.4	11.4	15.1	15.1	15.1	15.1	15.1	15.1

Table 2. Drive cooling

	Unit Size (tons)							
	Standard Length Unit				Extended Length Units ^(a)			
	150S - 165S	150	165-250	275-300	150S - 165S	150	165-250	275-300
Drive Cooling Fluid Type	Trane Heat Transfer Fluid CHM01023							
Fluid Volume (gal)								
Ckt 1	1.28	1.14	1.23	1.32	1.37	1.30	1.32	1.41
Ckt2	n/a	1.32	1.67	1.81	n/a	1.67	1.81	1.95
Total	1.28	2.46	2.89	3.12	1.37	2.97	3.12	3.36
Fluid Volume (l)								
Ckt1	4.86	4.30	4.64	4.98	5.20	4.93	4.98	5.33
Ckt2	n/a	5.01	6.31	6.84	n/a	6.31	6.84	7.38
Total	4.86	9.31	10.95	11.83	5.20	11.23	11.83	12.71

(a) Units are extended length if either of the following are selected:
 Transformer (model number digit 28 = 1)
 Harmonic Filtration Option (model number digit 29 = 1)
 Units without Harmonic Filtration Option or Transformer (digits 28, 29 = 0X) are standard length.



Controls

Tracer UC800 Controller

Today's Stealth™ chillers offer predictive controls that anticipate and compensate for load changes. Other control strategies made possible with the Tracer UC800 controls are:

Feedforward Adaptive Control

Feedforward is an open-loop, predictive control strategy designed to anticipate and compensate for load changes. It uses evaporator entering-water temperature as an indication of load change. This allows the controller to respond faster and maintain stable leaving-water temperatures.

Soft Loading

The chiller controller uses soft loading except during manual operation. Large adjustments due to load or setpoint changes are made gradually, preventing the compressor from cycling unnecessarily. It does this by internally filtering the setpoints to avoid reaching the differential-to-stop or the demand limit. Soft loading applies to the leaving chilled-water temperature and demand limit setpoints.

Adaptive Controls

Adaptive Controls directly sense the control variables that govern the operation of the chiller: evaporator pressure and condenser pressure. When any one of these variables approaches a limit condition when damage may occur to the unit or shutdown on a safety, Adaptive Controls takes corrective action to avoid shutdown and keep the chiller operating. This happens through combined actions of compressor and/or fan staging. Whenever possible, the chiller is allowed to continue making chilled water. This keeps cooling capacity available until the problem can be solved. Overall, the safety controls help keep the building or process running and out of trouble.

Rapid Restart

A Rapid Restart is performed after a momentary power loss occurs during operation. Similarly, if the chiller shuts down on a non-latching diagnostic and the diagnostic later clears itself, a Rapid Restart will be initiated.

AdaptiSpeed Control

Compressor speed is used to control capacity of the chiller, optimizing mathematically with the condenser fan speed to provide the highest level of performance. The increased performance of the UC800 Controller allows the chiller to operate longer at higher efficiency, and with greater stability.

Variable-Primary Flow (VPF)

Chilled-water systems that vary the water flow through chiller evaporators have caught the attention of engineers, contractors, building owners, and operators. Varying the water flow reduces the energy consumed by pumps, while having limited affect on the chiller energy consumption. This strategy can be a significant source of energy savings, depending on the application.

Tracer AdaptiView TD7 Operator Interface

The standard Tracer AdaptiView™ TD7 display provided with the Trane UC800 controller features a 7" LCD touch-screen, allowing access to all operational inputs and outputs. This is an advanced interface that allows the user to access any important information concerning setpoints, active temperatures, modes, electrical data, pressure, and diagnostics. It uses full text display available in 26 languages.

Display Features Include:

- LCD touch-screen with LED backlighting, for scrolling access to input and output operating information
- Single-screen, folder/tab-style display of all available information on individual components (evaporator, condenser, compressor, etc.)
- Manual override indication
- Password entry/lockout system to enable or disable display
- Automatic and immediate stop capabilities for standard or immediate manual shutdown
- Fast, easy access to available chiller data in tabbed format, including:
 - Easy to view Operating Modes
 - Logical Sub-Component Reports:
 - Evaporator
 - Condenser
 - Compressor
 - Motor
 - 3 User Programmable Custom Reports
 - ASHRAE report
 - Logsheet Report
 - Alarms Report
 - 8 pre-defined Standard Graphs
 - 4 User Programmable Custom Graphs
 - Chiller Settings
 - Feature Settings
 - Chilled Water Reset
 - Manual Control Settings
 - Globalization Settings
 - Support of 26 languages
 - Brightness Setting
 - Cleaning Mode

Tracer TU Interface

Tracer™ TU (non-Trane personnel, contact your local Trane office for software) adds a level of sophistication that improves service technician effectiveness and minimizes chiller downtime. The Tracer AdaptiView™ control's operator interface is intended to serve only typical daily tasks. The portable PC-based service-tool software, Tracer TU, supports service and maintenance tasks.

Tracer TU serves as a common interface to all Trane® chillers, and will customize itself based on the properties of the chiller with which it is communicating. Thus, the service technician learns only one service interface.

The panel bus is easy to troubleshoot using LED sensor verification. Only the defective device is replaced. Tracer TU can communicate with individual devices or groups of devices.

All chiller status, machine configuration settings, customizable limits, and up to 100 active or historic diagnostics are displayed through the service-tool software interface.

LEDs and their respective Tracer TU indicators visually confirm the availability of each connected sensor, relay, and actuator.

Tracer TU is designed to run on a customer's laptop, connected to the Tracer AdaptiView control panel with a USB cable. Your laptop must meet the following hardware and software requirements:

- 1 GB RAM (minimum)
- 1024 x 768 screen resolution
- CD-ROM drive
- Ethernet 10/100 LAN card
- An available USB 2.0 port
- Microsoft® Windows® XP Professional operation system with Service Pack 3 (SP3) or Windows 7 Enterprise or Professional operating system (32-bit or 64-bit)
- Microsoft .NET Framework 4.0 or later

Note: *Tracer TU is designed and validated for this minimum laptop configuration. Any variation from this configuration may have different results. Therefore, support for Tracer TU is limited to only those laptops with the configuration previously specified.*

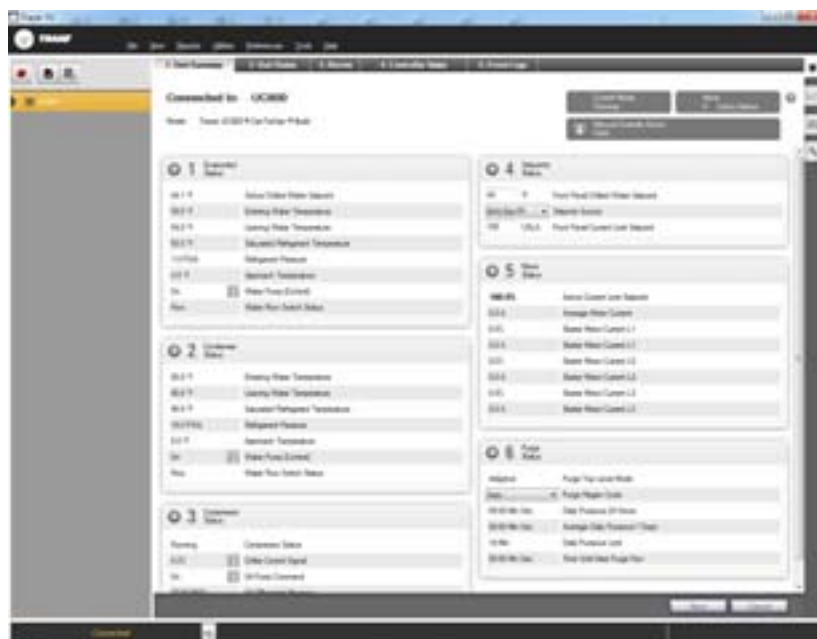

System Integration

Stand-Alone Controls

Single chillers installed in applications without a building management system are simple to install and control: only a remote auto/stop for scheduling is required for unit operation. Signals from the chilled-water pump contactor auxiliary, or a flow switch, are wired to the chilled-water flow interlock. Signals from a time clock or some other remote device are wired to the external auto/stop input.

- Auto/Stop - A job-site provided contact closure turns the unit on and off.
- Emergency Stop - A job-site provided contact opening wired to this input turns the unit off and requires a manual reset of the unit microcomputer. This closure is typically triggered by a job-site provided system such as a fire alarm.

Hardwire Points

Microcomputer controls allow simple interface with other control systems, such as time clocks, building automation systems, and ice storage systems via hardwire points. This means you have the flexibility to meet job requirements while not having to learn a complicated control system.

Remote devices are wired from the control panel to provide auxiliary control to a building automation system. Inputs and outputs can be communicated via a typical 4–20 mA electrical signal, an equivalent 2–10 Vdc signal, or by utilizing contact closures.

This setup has the same features as a stand-alone water chiller, with the possibility of having additional optional features:

- Ice making control
- External chilled water setpoint, external demand limit setpoint
- Chilled water temperature reset
- Programmable relays - available outputs are: alarm-latching, alarm-auto reset, general alarm, warning, chiller limit mode, compressor running, and Tracer control.

BACnet Interface

Tracer AdaptiView control can be configured for BACnet[®] communications at the factory or in the field. This enables the chiller controller to communicate on a BACnet MS/TP network. Chiller setpoints, operating modes, alarms, and status can be monitored and controlled through BACnet.

Tracer AdaptiView controls conform to the BACnet B-ASC profile as defined by ASHRAE 135-2004.

LonTalk Communications Interface (LCI-C)

The optional LonTalk[®] Communications Interface for Chillers (LCI-C) is available factory or field installed. It is an integrated communication board that enables the chiller controller to communicate over a LonTalk network. The LCI-C is capable of controlling and monitoring chiller setpoints, operating modes, alarms, and status. The Trane LCI-C provides additional points beyond the standard LONMARK[®] defined chiller profile to extend interoperability and support a broader range of system applications. These added points are referred to as open extensions. The LCI-C is certified to the LONMARK Chiller Controller Functional Profile 8040 version 1.0, and follows LonTalk FTT-10A free topology communications.

Modbus Interface

Tracer AdaptiView control can be configured for Modbus[™] communications at the factory or in the field. This enables the chiller controller to communicate as a slave device on a Modbus network. Chiller setpoints, operating modes, alarms, and status can be monitored and controlled by a Modbus master device.

Tracer SC

The Tracer SC™ system controller acts as the central coordinator for all individual equipment devices on a Tracer building automation system. The Tracer SC scans all unit controllers to update information and coordinate building control, including building subsystems such as VAV and chiller water systems. With this system option, the full breadth of Trane's HVAC and controls experience are applied to offer solutions to many facility issues. The LAN allows building operators to manage these varied components as one system from any personal computer with web access. The benefits of this system are:

- Improved usability with automatic data collection, enhanced data logging, easier to create graphics, simpler navigation, pre-programmed scheduling, reporting, and alarm logs.
- Flexible technology allows for system sizes from 30-120 unit controllers with any combination of LonTalk or BACnet unit controllers.
- LEED certification through site commissioning report, energy data collection measurement, optimizing energy performance, and maintaining indoor air quality.

Energy savings programs include: fan pressure optimization, ventilation reset, and chiller plant control (adds and subtracts chillers to meet cooling loads).

Building Automation and Chiller Plant Control

The UC800 controller can communicate with Trane Tracer SC and Tracer ES building automation systems, which include pre-engineered and flexible control for chiller plants. These building automation systems can control the operation of the complete installation: chillers, pumps, isolating valves, air handlers, and terminal units. Trane can undertake full responsibility for optimized automation and energy management for the entire chiller plant. The main functions are:

- **Chiller sequencing:** equalizes the number of running hours of the chillers. Different control strategies are available depending on the configuration of the installation.
- **Control of the auxiliaries:** includes input/output modules to control the operation of the various auxiliary equipment (water pumps, valves, etc.)
- **Time-of-day scheduling:** allows the end user to define the occupancy period, for example: time of the day, holiday periods and exception schedules.
- **Optimization of the installation start/stop time:** based on the programmed schedule of occupancy and the historical temperature records. Tracer SC calculates the optimal start/stop time of the installation to get the best compromise between energy savings and comfort of the occupants.
- **Soft loading:** the soft loading function minimizes the number of chillers that are operated to satisfy a large chilled-water-loop pull down, thus preventing an overshoot of the actual capacity required. Unnecessary starts are avoided and the peak current demand is lowered.
- **Communication capabilities:** local, through a PC workstation keyboard. Tracer SC can be programmed to send messages to other local or remote workstations and or a pager in the following cases:
 - Analog parameter exceeding a programmed value
 - Maintenance warning
 - Component failure alarm
 - Critical alarm messages. In this latter case, the message is displayed until the operator acknowledges the receipt of the information. From the remote station it is also possible to access and modify the chiller plants control parameters.
- **Remote communication through a modem:** as an option, a modem can be connected to communicate the plant operation parameters through voice grade phone lines.

A remote terminal is a PC workstation equipped with a modem and software to display the remote plant parameters.

Integrated Comfort System (ICS)

The onboard Tracer chiller controller is designed to be able to communicate with a wide range of building automation systems. In order to take full advantage of chiller's capabilities, incorporate your chiller into a Tracer SC building automation system.

But the benefits do not stop at the chiller plant. At Trane, we realize that all the energy used in your cooling system is important. That is why we worked closely with other equipment manufacturers to predict the energy required by the entire system. We used this information to create patented control logic for optimizing HVAC system efficiency.

The building owners challenge is to tie components and applications expertise into a single reliable system that provides maximum comfort, control, and efficiency. Trane Integrated Comfort systems (ICS) are a concept that combines system components, controls, and engineering applications expertise into a single, logical, and efficient system. These advanced controls are fully commissioned and available on every piece of Trane® equipment, from the largest chiller to the smallest VAV box. As a manufacturer, only Trane offers this universe of equipment, controls, and factory installation and verification.



Electrical

Electrical Data

Table 3. Electrical data — 60 Hz — all ambients

Unit Size	Rated Voltage ^(c)	AFD Input Amps ^(a)		Fans			Control VA ^(b)		MCA ^(e)	MOP ^(f)
		Comp A	Comp B	Qty ^(d)	kW	FLA	Without Harmonic Filtration (model # digit 29 = X)	With Harmonic Filtration (model # digit 29 = 1)		
150S	200/60/3	221	-	8	2.05	2.7	1074	-	693	1000
	230/60/3	221	-	8	2.05	2.7	1074	-	603	1000
	380/60/3	268	-	8	2.05	3.3	574	-	365	600
	400/60/3	254	-	8	2.05	3.1	574	-	347	500
	460/60/3	221	-	8	2.05	2.7	574	-	302	500
	575/60/3	221	-	8	2.05	2.7	1074	-	242	400
165S	200/60/3	235	-	10	2.05	2.7	1074	-	745	120
	230/60/3	235	-	10	2.05	2.7	1074	-	648	1000
	380/60/3	285	-	10	2.05	3.3	574	-	393	600
	400/60/3	270	-	10	2.05	3.1	574	-	373	600
	460/60/3	235	-	10	2.05	2.7	574	-	324	500
	575/60/3	235	-	10	2.05	2.7	1074	-	260	400
150	200/60/3	124	124	8	2.05	2.7	1394	-	722	1000
	230/60/3	124	124	8	2.05	2.7	1394	-	613	800
	380/60/3	151	151	8	2.05	3.3	894	1394	369	500
	400/60/3	143	143	8	2.05	3.1	894	1394	350	450
	460/60/3	124	124	8	2.05	2.7	894	1394	305	400
	575/60/3	124	124	8	2.05	2.7	1394	-	246	350
165	200/60/3	130	130	10	2.05	2.7	1394	-	761	1000
	230/60/3	130	130	10	2.05	2.7	1394	-	646	800
	380/60/3	157	157	10	2.05	3.3	894	1394	392	500
	400/60/3	150	150	10	2.05	3.1	894	1394	372	500
	460/60/3	130	130	10	2.05	2.7	894	1394	323	450
	575/60/3	130	130	10	2.05	2.7	1394	-	259	350
180	200/60/3	143	143	10	2.05	2.7	1394	-	830	1000
	230/60/3	143	143	10	2.05	2.7	1394	-	704	1000
	380/60/3	173	173	10	2.05	3.3	894	1394	427	600
	400/60/3	165	165	10	2.05	3.1	894	1394	405	500
	460/60/3	143	143	10	2.05	2.7	894	1394	352	450
	575/60/3	143	143	10	2.05	2.7	1394	-	282	400
200	200/60/3	154	154	12	2.05	2.7	1394	-	901	1200
	230/60/3	154	154	12	2.05	2.7	1394	-	765	1000
	380/60/3	186	186	12	2.05	3.3	894	1394	463	600
	400/60/3	177	177	12	2.05	3.1	894	1394	440	600
	460/60/3	154	154	12	2.05	2.7	894	1394	383	500
	575/60/3	154	154	12	2.05	2.7	1394	-	307	400

Table 3. Electrical data – 60 Hz – all ambients (continued)

Unit Size	Rated Voltage ^(c)	AFD Input Amps ^(a)		Fans			Control VA ^(b)		MCA ^(e)	MOP ^(f)
		Comp A	Comp B	Qty ^(d)	kW	FLA	Without Harmonic Filtration (model # digit 29 = X)	With Harmonic Filtration (model # digit 29 = 1)		
225	200/60/3	160	160	12	2.05	2.7	1434	-	933	1200
	230/60/3	160	160	12	2.05	2.7	1434	-	792	1000
	380/60/3	194	194	12	2.05	3.3	934	1434	480	600
	400/60/3	184	184	12	2.05	3.1	934	1434	455	600
	460/60/3	160	160	12	2.05	2.7	934	1434	396	500
	575/60/3	160	160	12	2.05	2.7	1434	-	317	450
250	200/60/3	186	186	12	2.05	2.7	1434	-	1071	1200
	230/60/3	186	186	12	2.05	2.7	1434	-	909	1200
	380/60/3	225	225	12	2.05	3.3	934	1434	551	700
	400/60/3	213	213	12	2.05	3.1	934	1434	523	700
	460/60/3	186	186	12	2.05	2.7	934	1434	455	600
	575/60/3	186	186	12	2.05	2.7	1434	-	364	500
275	200/60/3	199	199	14	2.05	2.7	1434	-	1153	1600
	230/60/3	199	199	14	2.05	2.7	1434	-	978	1200
	380/60/3	241	241	14	2.05	3.3	934	1434	593	800
	400/60/3	229	229	14	2.05	3.1	934	1434	563	700
	460/60/3	199	199	14	2.05	2.7	934	1434	489	600
	575/60/3	199	199	14	2.05	2.7	1434	-	392	500
300	200/60/3	215	215	16	2.05	2.7	1434	-	1250	1600
	230/60/3	215	215	16	2.05	2.7	1434	-	1061	1200
	380/60/3	260	260	16	2.05	3.3	934	1434	643	800
	400/60/3	247	247	16	2.05	3.1	934	1434	610	800
	460/60/3	215	215	16	2.05	2.7	934	1434	531	700
	575/60/3	215	215	16	2.05	2.7	1434	-	425	600

(a) All 200, 230 and 575V units consist of a voltage autotransformer with a 460V unit downstream. As a result, AFD input amp draws for these voltages are the same as those of a corresponding 460V unit.

(b) Control VA includes operational controls only. It does not include evaporator heaters. A separate 115/60/1, 15 amp customer provided power connection is required to power the evaporator heaters (150T-165T: 800 watts, 180T-300T: 1200 watts).

(c) Voltage Utilization Range: +/- 1-% of Rated voltage (use range): 200/60/3 (180-220), 230/60/3 (208-254), 380/60/3 (342-418), 400/60/3 (360-440), 400/50/3 (360-440), 460/60/3 (414-506), 575/60/3 (516-633)

(d) Number of fans is evenly distributed between the two chiller circuits.

(e) MCA - Minimum Circuit Ampacity - 125 percent of largest compressor VFD input plus 100 percent of all other loads for 380V, 400V, and 460V incoming voltage. All other voltages need to have the 460V calculation reflected to the appropriate voltage.

(f) Max fuse or MOPD = 225 percent of largest compressor VFD input plus 100 percent of second compressor VFD input, plus sum of condenser fan FLA.



Electrical

Table 4. Electrical data – 50 Hz – all ambients

Unit Size	Rated Voltage ^(b)	AFD Input Amps		Fans			Control VA ^(a)		MCA ^(d)	MOP ^(e)
		Comp A	Comp B	Qty ^(c)	kW	FLA	Without Harmonic Filtration (model # digit 29 = X)	With Harmonic Filtration (model # digit 29 = 1)		
150S	380/50/3	268	-	8	2.05	3.3	574	-	365	600
	400/50/3	254	-	8	2.05	3.1	574	-	347	500
165S	380/50/3	285	-	10	2.05	3.3	574	-	393	600
	400/50/3	270	-	10	2.05	3.1	574	-	373	600
150	380/50/3	151	151	8	2.05	3.3	894	1394	369	500
	400/50/3	143	143	8	2.05	3.1	894	1394	350	450
165	380/50/3	157	157	10	2.05	3.3	894	1394	392	500
	400/50/3	150	150	10	2.05	3.1	894	1394	372	500
180	380/50/3	173	173	10	2.05	3.3	894	1394	427	600
	400/50/3	165	165	10	2.05	3.1	894	1394	405	500
200	380/50/3	186	186	12	2.05	3.3	894	1394	463	600
	400/50/3	177	177	12	2.05	3.1	894	1394	440	600
225	380/50/3	194	194	12	2.05	3.3	934	1434	480	600
	400/50/3	184	184	12	2.05	3.1	934	1434	455	600
250	380/50/3	225	225	12	2.05	3.3	934	1434	551	700
	400/50/3	213	213	12	2.05	3.1	934	1434	523	700
275	380/50/3	241	241	14	2.05	3.3	934	1434	593	800
	400/50/3	229	229	14	2.05	3.1	934	1434	563	700
300	380/50/3	260	260	16	2.05	3.3	934	1434	643	800
	400/50/3	247	247	16	2.05	3.1	934	1434	610	800

(a) Control VA includes operational controls only. It does not include evaporator heaters. A separate 115/60/1, 15 amp customer provided power connection is required to power the evaporator heaters (150T-165T; 800 watts, 180T-300T; 1200 watts).

(b) Voltage Utilization Range: +/- 1-% of Rated voltage (use range): 200/60/3 (180-220), 230/60/3 (208-254), 380/60/3 (342-418), 400/60/3 (360-440), 400/50/3 (360-440), 460/60/3 (414-506), 575/60/3 (516-633)

(c) Number of fans is evenly distributed between the two chiller circuits.

(d) MCA - Minimum Circuit Ampacity - 125 percent of largest compressor VFD input plus 100 percent of all other loads

(e) Max fuse or MOPD = 225 percent of largest compressor VFD input plus 100 percent of second compressor VFD input, plus sum of condenser fan FLA.

Customer Wiring

Table 5. Customer wire selection^(a) – 60 Hz

Unit Size	Volt	Terminal Block	Circuit Breaker	Circuit Breaker - High Fault
150S	200	(4) 2 AWG - 600MCM	n/a	(4) 3/0 AWG - 500MCM
	230	(4) 2 AWG - 600MCM	n/a	(4) 3/0 AWG - 500MCM
	380	(2) 4 AWG - 500MCM	(2) 4/0 AWG - 500MCM	(2) 4/0 AWG - 500MCM
	400	(2) 4 AWG - 500MCM	(2) 4/0 AWG - 500MCM	(2) 4/0 AWG - 500MCM
	460	(2) 4 AWG - 500MCM	(2) 4/0 AWG - 500MCM	(2) 4/0 AWG - 500MCM
	575	(2) 4 AWG - 500MCM	(3) 3/0 AWG - 500MCM	(3) 3/0 AWG - 500MCM
165S	200	(4) 2 AWG - 600MCM	n/a	(4) 3/0 AWG - 500MCM
	230	(4) 2 AWG - 600MCM	n/a	(4) 3/0 AWG - 500MCM
	380	(2) 4 AWG - 500MCM	(2) 4/0 AWG - 500MCM	(2) 4/0 AWG - 500MCM
	400	(2) 4 AWG - 500MCM	(2) 4/0 AWG - 500MCM	(2) 4/0 AWG - 500MCM
	460	(2) 4 AWG - 500MCM	(2) 4/0 AWG - 500MCM	(2) 4/0 AWG - 500MCM
	575	(2) 4 AWG - 500MCM	(3) 3/0 AWG - 500MCM	(3) 3/0 AWG - 500MCM
150	200	(4) 2 AWG - 600MCM	n/a	(4) 3/0 AWG - 500MCM
	230	(4) 2 AWG - 600MCM	(3) 3/0 AWG - 500MCM	(3) 3/0 AWG - 500MCM
	380	(2) 4 AWG - 500MCM	(2) 4/0 AWG - 500MCM	(2) 4/0 AWG - 500MCM
	400	(2) 4 AWG - 500MCM	(2) 4/0 AWG - 500MCM	(2) 4/0 AWG - 500MCM
	460	(2) 4 AWG - 500MCM	(2) 4/0 AWG - 500MCM	(2) 4/0 AWG - 500MCM
	575	(2) 4 AWG - 500MCM	(3) 3/0 AWG - 500MCM	(3) 3/0 AWG - 500MCM
165	200	(4) 2 AWG - 600MCM	n/a	(4) 3/0 AWG - 500MCM
	230	(4) 2 AWG - 600MCM	(3) 3/0 AWG - 500MCM	(3) 3/0 AWG - 500MCM
	380	(2) 4 AWG - 500MCM	(2) 4/0 AWG - 500MCM	(2) 4/0 AWG - 500MCM
	400	(2) 4 AWG - 500MCM	(2) 4/0 AWG - 500MCM	(2) 4/0 AWG - 500MCM
	460	(2) 4 AWG - 500MCM	(2) 4/0 AWG - 500MCM	(2) 4/0 AWG - 500MCM
	575	(2) 4 AWG - 500MCM	(3) 3/0 AWG - 500MCM	(3) 3/0 AWG - 500MCM
180	200	(4) 2 AWG - 600MCM	n/a	(4) 3/0 AWG - 500MCM
	230	(4) 2 AWG - 600MCM	n/a	(4) 3/0 AWG - 500MCM
	380	(2) 4 AWG - 500MCM	(2) 4/0 AWG - 500MCM	(2) 4/0 AWG - 500MCM
	400	(2) 4 AWG - 500MCM	(2) 4/0 AWG - 500MCM	(2) 4/0 AWG - 500MCM
	460	(2) 4 AWG - 500MCM	(2) 4/0 AWG - 500MCM	(2) 4/0 AWG - 500MCM
	575	(2) 4 AWG - 500MCM	(3) 3/0 AWG - 500MCM	(3) 3/0 AWG - 500MCM
200	200	(4) 2 AWG - 600MCM	n/a	(4) 3/0 AWG - 500MCM
	230	(4) 2 AWG - 600MCM	n/a	(4) 3/0 AWG - 500MCM
	380	(2) 4 AWG - 500MCM	(2) 4/0 AWG - 500MCM	(2) 4/0 AWG - 500MCM
	400	(2) 4 AWG - 500MCM	(2) 4/0 AWG - 500MCM	(2) 4/0 AWG - 500MCM
	460	(2) 4 AWG - 500MCM	(2) 4/0 AWG - 500MCM	(2) 4/0 AWG - 500MCM
	575	(2) 4 AWG - 500MCM	(3) 3/0 AWG - 500MCM	(3) 3/0 AWG - 500MCM
225	200	(4) 2 AWG - 600MCM	n/a	(4) 3/0 AWG - 500MCM
	230	(4) 2 AWG - 600MCM	n/a	(4) 3/0 AWG - 500MCM
	380	(2) 4 AWG - 500MCM	(2) 4/0 AWG - 500MCM	(2) 4/0 AWG - 500MCM
	400	(2) 4 AWG - 500MCM	(2) 4/0 AWG - 500MCM	(2) 4/0 AWG - 500MCM
	460	(2) 4 AWG - 500MCM	(2) 4/0 AWG - 500MCM	(2) 4/0 AWG - 500MCM
	575	(2) 4 AWG - 500MCM	(3) 3/0 AWG - 500MCM	(3) 3/0 AWG - 500MCM

Electrical

Table 5. Customer wire selection^(a) – 60 Hz (continued)

Unit Size	Volt	Terminal Block	Circuit Breaker	Circuit Breaker - High Fault
250	200	(4) 2 AWG - 600MCM	n/a	(4) 3/0 AWG - 500MCM
	230	(4) 2 AWG - 600MCM	n/a	(4) 3/0 AWG - 500MCM
	380	(2) 4 AWG - 500MCM	(3) 3/0 AWG - 500MCM	(3) 3/0 AWG - 500MCM
	400	(2) 4 AWG - 500MCM	(3) 3/0 AWG - 500MCM	(3) 3/0 AWG - 500MCM
	460	(2) 4 AWG - 500MCM	(2) 4/0 AWG - 500MCM	(2) 4/0 AWG - 500MCM
	575	(2) 4 AWG - 500MCM	(3) 3/0 AWG - 500MCM	(3) 3/0 AWG - 500MCM
275	200	(4) 2 AWG - 600MCM	n/a	(4) 3/0 AWG - 500MCM
	230	(4) 2 AWG - 600MCM	n/a	(4) 3/0 AWG - 500MCM
	380	(2) 4 AWG - 500MCM	(3) 3/0 AWG - 500MCM	(3) 3/0 AWG - 500MCM
	400	(2) 4 AWG - 500MCM	(3) 3/0 AWG - 500MCM	(3) 3/0 AWG - 500MCM
	460	(2) 4 AWG - 500MCM	(2) 4/0 AWG - 500MCM	(2) 4/0 AWG - 500MCM
	575	(2) 4 AWG - 500MCM	(3) 3/0 AWG - 500MCM	(3) 3/0 AWG - 500MCM
300	200	(4) 2 AWG - 600MCM	n/a	(4) 2 AWG - 600MCM
	230	(4) 2 AWG - 600MCM	n/a	(4) 2 AWG - 600MCM
	380	(2) 4 AWG - 500MCM	(3) 3/0 AWG - 500MCM	(3) 3/0 AWG - 500MCM
	400	(2) 4 AWG - 500MCM	(3) 3/0 AWG - 500MCM	(3) 3/0 AWG - 500MCM
	460	(2) 4 AWG - 500MCM	(3) 3/0 AWG - 500MCM	(3) 3/0 AWG - 500MCM
	575	(2) 4 AWG - 500MCM	(3) 3/0 AWG - 500MCM	(3) 3/0 AWG - 500MCM

(a) Field wire insulation temperature rating must be minimum 90°C unless otherwise specified.

Table 6. Customer wire selection^(a) – 50 Hz

Unit Size	Volt	Terminal Block	Circuit Breaker	Circuit Breaker - High Fault
150	380	(2) 4 AWG - 500MCM	(2) 4/0 AWG - 500MCM	(2) 4/0 AWG - 500MCM
	400	(2) 4 AWG - 500MCM	(2) 4/0 AWG - 500MCM	(2) 4/0 AWG - 500MCM
165	380	(2) 4 AWG - 500MCM	(2) 4/0 AWG - 500MCM	(2) 4/0 AWG - 500MCM
	400	(2) 4 AWG - 500MCM	(2) 4/0 AWG - 500MCM	(2) 4/0 AWG - 500MCM
150	380	(2) 4 AWG - 500MCM	(2) 4/0 AWG - 500MCM	(2) 4/0 AWG - 500MCM
	400	(2) 4 AWG - 500MCM	(2) 4/0 AWG - 500MCM	(2) 4/0 AWG - 500MCM
165	380	(2) 4 AWG - 500MCM	(2) 4/0 AWG - 500MCM	(2) 4/0 AWG - 500MCM
	400	(2) 4 AWG - 500MCM	(2) 4/0 AWG - 500MCM	(2) 4/0 AWG - 500MCM
180	380	(2) 4 AWG - 500MCM	(2) 4/0 AWG - 500MCM	(2) 4/0 AWG - 500MCM
	400	(2) 4 AWG - 500MCM	(2) 4/0 AWG - 500MCM	(2) 4/0 AWG - 500MCM
200	380	(2) 4 AWG - 500MCM	(2) 4/0 AWG - 500MCM	(2) 4/0 AWG - 500MCM
	400	(2) 4 AWG - 500MCM	(2) 4/0 AWG - 500MCM	(2) 4/0 AWG - 500MCM
225	380	(2) 4 AWG - 500MCM	(2) 4/0 AWG - 500MCM	(2) 4/0 AWG - 500MCM
	400	(2) 4 AWG - 500MCM	(2) 4/0 AWG - 500MCM	(2) 4/0 AWG - 500MCM
250	380	(2) 4 AWG - 500MCM	(3) 3/0 AWG - 500MCM	(3) 3/0 AWG - 500MCM
	400	(2) 4 AWG - 500MCM	(3) 3/0 AWG - 500MCM	(3) 3/0 AWG - 500MCM
275	380	(2) 4 AWG - 500MCM	(3) 3/0 AWG - 500MCM	(3) 3/0 AWG - 500MCM
	400	(2) 4 AWG - 500MCM	(3) 3/0 AWG - 500MCM	(3) 3/0 AWG - 500MCM
300	380	(2) 4 AWG - 500MCM	(3) 3/0 AWG - 500MCM	(3) 3/0 AWG - 500MCM
	400	(2) 4 AWG - 500MCM	(3) 3/0 AWG - 500MCM	(3) 3/0 AWG - 500MCM

(a) Field wire insulation temperature rating must be minimum 90°C unless otherwise specified.

Electrical Connections

Figure 5. Single circuit units – field wiring sheet 1

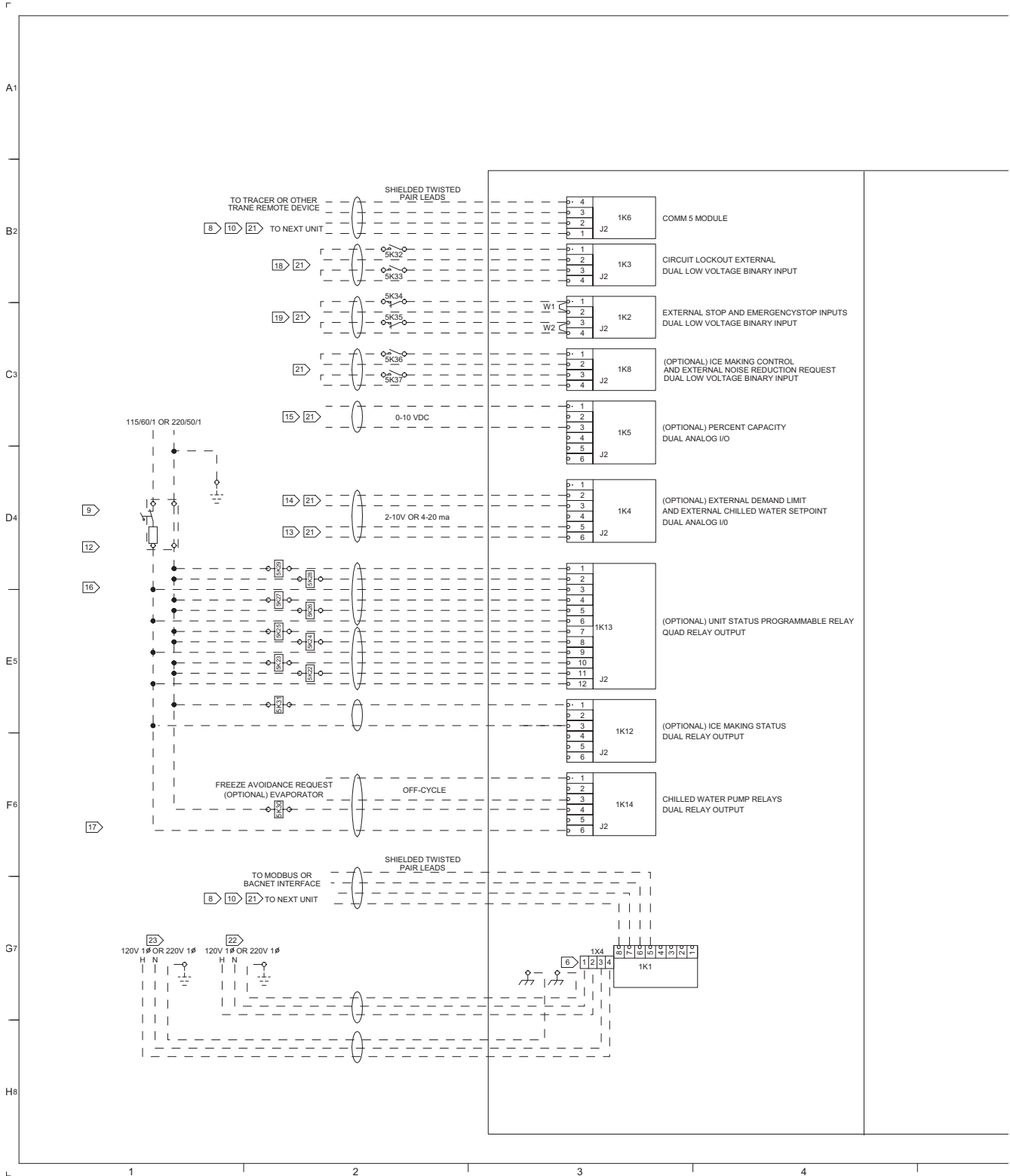
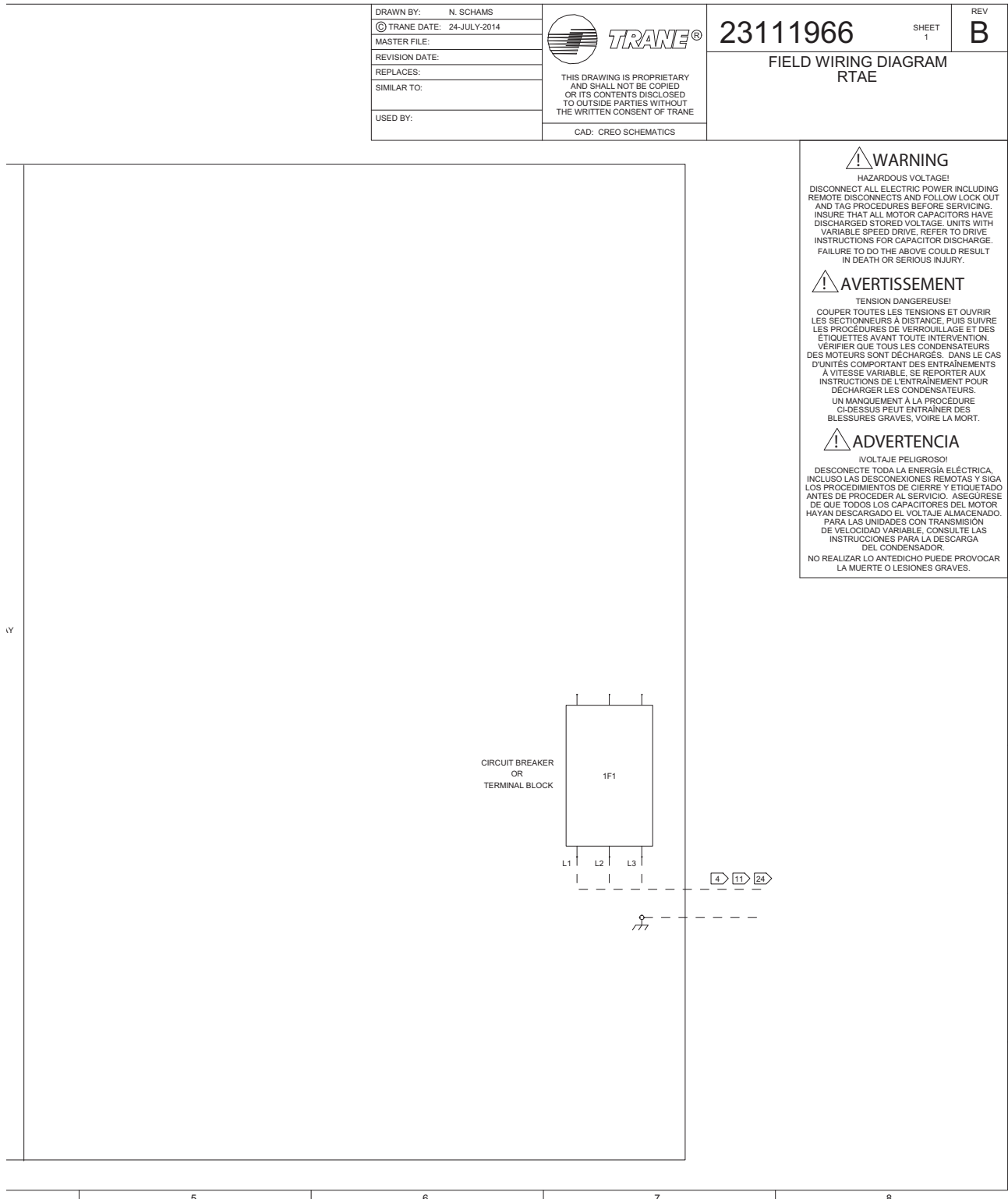

Figure 6. Single circuit units – field wiring sheet 1 (continued)



Electrical Connections

Figure 7. Single circuit units — field wiring sheet 2

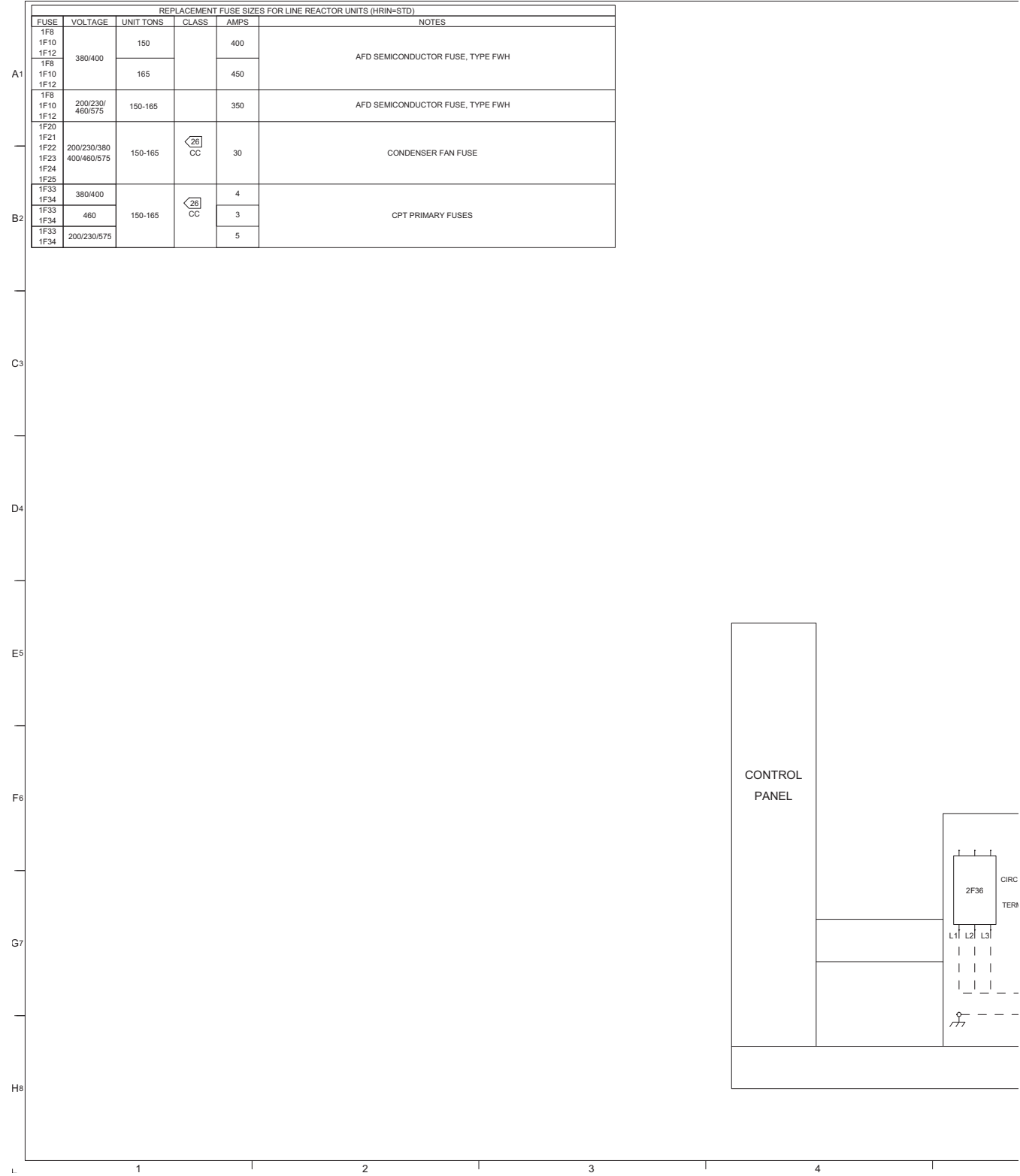
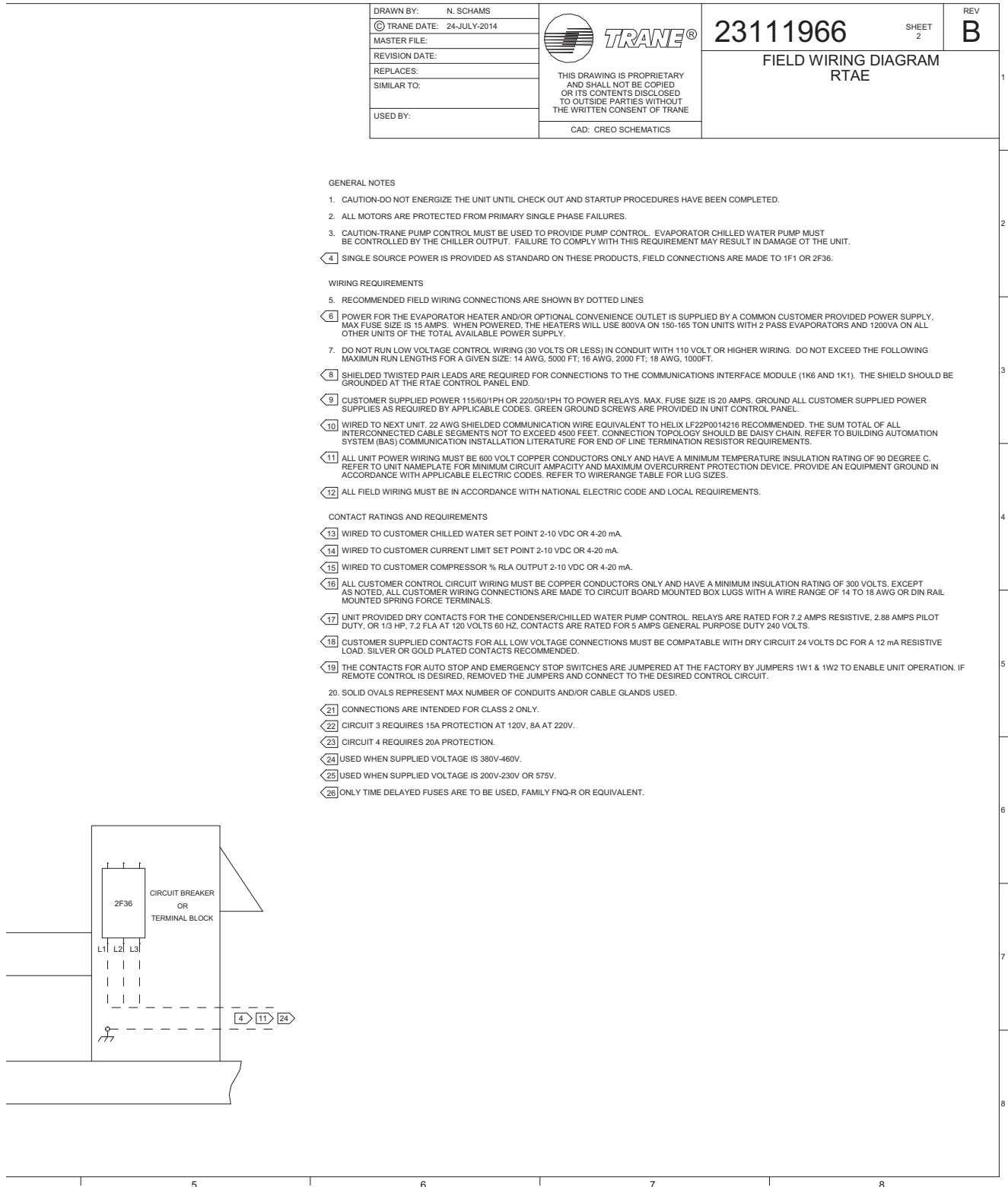

Figure 8. Single circuit units – field wiring sheet 2 (continued)



Electrical Connections

Figure 9. Dual circuit units — field wiring sheet 1

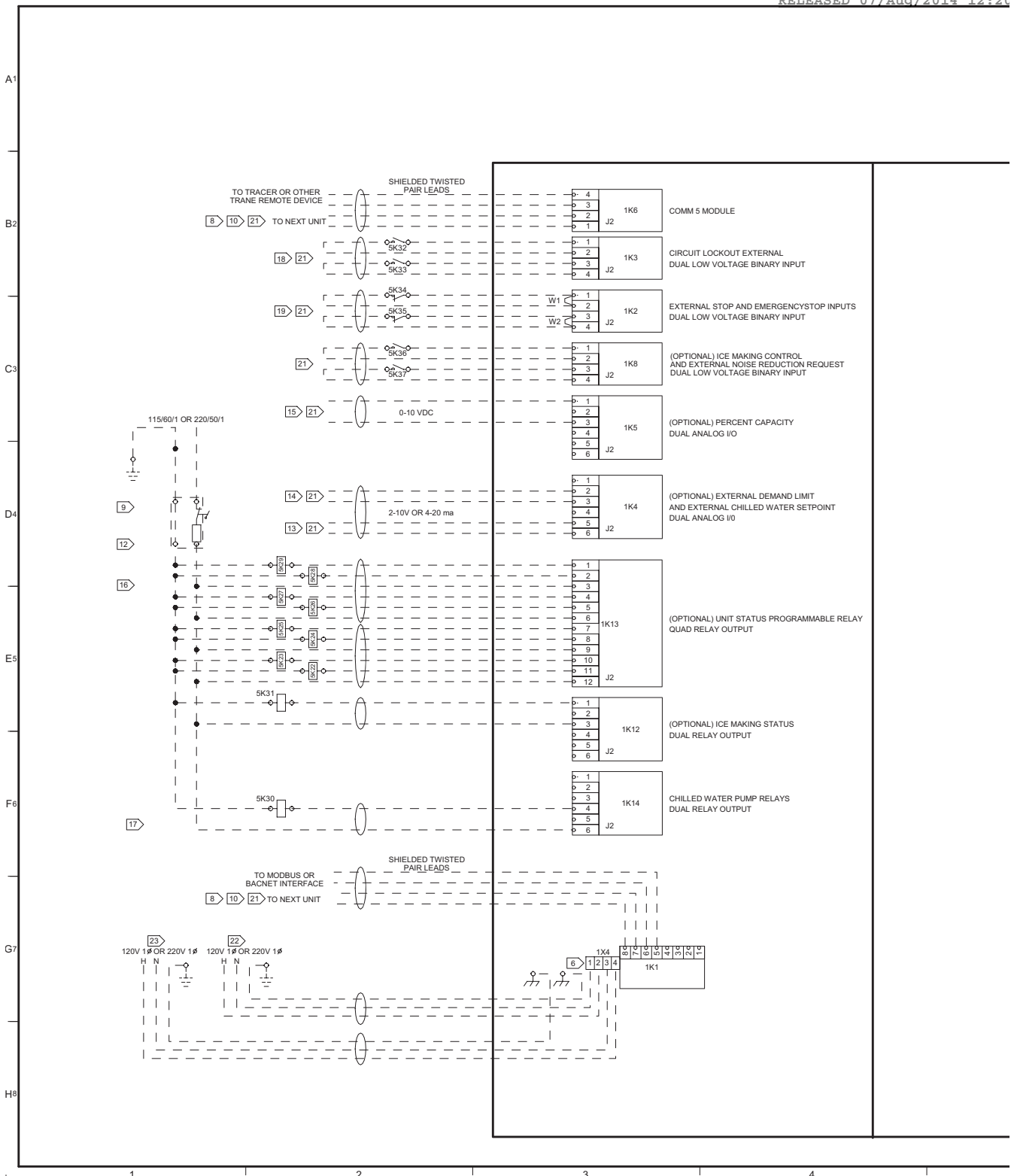
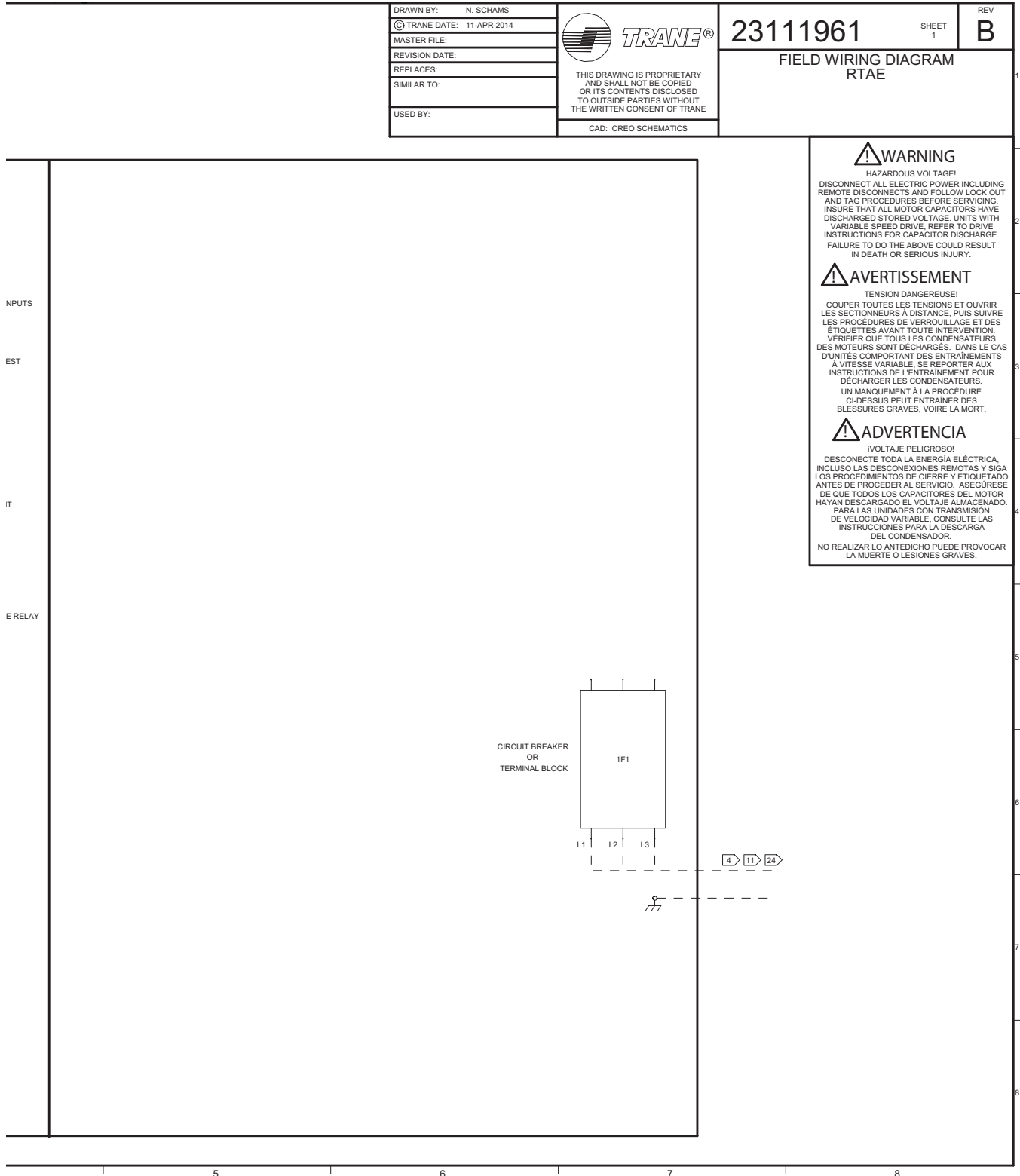

Figure 10. Dual circuit units — field wiring sheet 1 (continued)



Electrical Connections

Figure 11. Dual circuit units — field wiring sheet 2

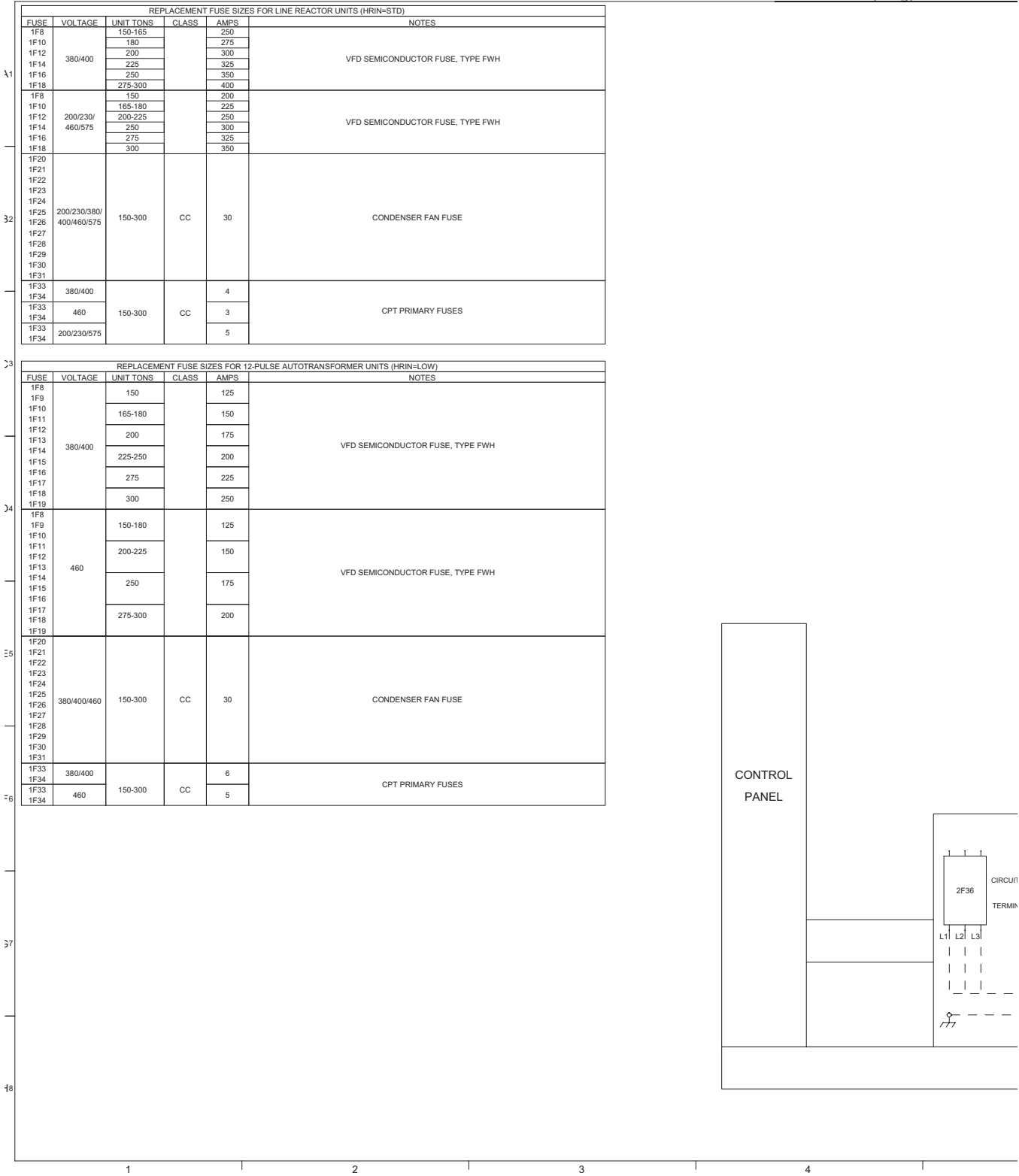

Figure 12. Dual circuit units — field wiring sheet 2 (continued)

DRAWN BY: N. SCHAMS © TRANE DATE: 11-APR-2014 MASTER FILE: REVISION DATE: REPLACES: SIMILAR TO: USED BY:		23111961 SHEET 2 B	REV
THIS DRAWING IS PROPRIETARY AND SHALL NOT BE COPIED OR ITS CONTENTS DISCLOSED TO OUTSIDE PARTIES WITHOUT THE WRITTEN CONSENT OF TRANE. CAD: CREO SCHEMATICS		FIELD WIRING DIAGRAM RTAE	

GENERAL NOTES

1. CAUTION-DO NOT ENERGIZE THE UNIT UNTIL CHECK OUT AND STARTUP PROCEDURES HAVE BEEN COMPLETED.
2. ALL MOTORS ARE PROTECTED FROM PRIMARY SINGLE PHASE FAILURES.
3. CAUTION-TRANE PUMP CONTROL MUST BE USED TO PROVIDE PUMP CONTROL. EVAPORATOR CHILLED WATER PUMP MUST BE CONTROLLED BY THE CHILLER OUTPUT. FAILURE TO COMPLY WITH THIS REQUIREMENT MAY RESULT IN DAMAGE OT THE UNIT.
- 4 SINGLE SOURCE POWER IS PROVIDED AS STANDARD ON THESE PRODUCTS. FIELD CONNECTIONS ARE MADE TO 1F1 OR 2F36.

WIRING REQUIREMENTS

5. RECOMMENDED FIELD WIRING CONNECTIONS ARE SHOWN BY DOTTED LINES
- 6 POWER FOR THE EVAPORATOR HEATER AND/OR OPTIONAL CONVENIENCE OUTLET IS SUPPLIED BY A COMMON CUSTOMER PROVIDED POWER SUPPLY. MAX FUSE SIZE IS 15 AMPS. WHEN POWERED, THE HEATERS WILL USE 800VA ON 150-165 TON UNITS WITH 2 PASS EVAPORATORS AND 1200VA ON ALL OTHER UNITS OF THE TOTAL AVAILABLE POWER SUPPLY.
7. DO NOT RUN LOW VOLTAGE CONTROL WIRING (30 VOLTS OR LESS) IN CONDUIT WITH 110 VOLT OR HIGHER WIRING. DO NOT EXCEED THE FOLLOWING MAXIMUM RUN LENGTHS FOR A GIVEN SIZE: 14 AWG, 5000 FT; 16 AWG, 2000 FT; 18 AWG, 1000FT.
- 8 SHIELDED TWISTED PAIR LEADS ARE REQUIRED FOR CONNECTIONS TO THE COMMUNICATIONS INTERFACE MODULE (1K6 AND 1K1). THE SHIELD SHOULD BE GROUNDED AT THE RTAE CONTROL PANEL END.
- 9 CUSTOMER SUPPLIED POWER 115/60/1PH OR 220/50/1PH TO POWER RELAYS. MAX. FUSE SIZE IS 20 AMPS. GROUND ALL CUSTOMER SUPPLIED POWER SUPPLIES AS REQUIRED BY APPLICABLE CODES. GREEN GROUND SCREWS ARE PROVIDED IN UNIT CONTROL PANEL.
- 10 WIRE TO NEXT UNIT. 22 AWG SHIELDED COMMUNICATION WIRE EQUIVALENT TO HELIX LF22P0014216 RECOMMENDED. THE SUM TOTAL OF ALL INTERCONNECTED CABLE SEGMENTS NOT TO EXCEED 4500 FEET. CONNECTION TOPOLOGY SHOULD BE DAISY CHAIN. REFER TO BUILDING AUTOMATION SYSTEM (BAS) COMMUNICATION INSTALLATION LITERATURE FOR END OF LINE TERMINATION RESISTOR REQUIREMENTS.
- 11 ALL UNIT POWER WIRING MUST BE 600 VOLT COPPER CONDUCTORS ONLY AND HAVE A MINIMUM TEMPERATURE INSULATION RATING OF 90 DEGREE C. REFER TO UNIT NAMEPLATE FOR MINIMUM CIRCUIT AMPACITY AND MAXIMUM OVERCURRENT PROTECTION DEVICE. PROVIDE AN EQUIPMENT GROUND IN ACCORDANCE WITH APPLICABLE ELECTRIC CODES. REFER TO WIRERANGE TABLE FOR LUG SIZES.
- 12 ALL FIELD WIRING MUST BE IN ACCORDANCE WITH NATIONAL ELECTRIC CODE AND LOCAL REQUIREMENTS.

CONTACT RATINGS AND REQUIREMENTS

- 13 WIRE TO CUSTOMER CHILLED WATER SET POINT 2-10 VDC OR 4-20 mA.
- 14 WIRE TO CUSTOMER CURRENT LIMIT SET POINT 2-10 VDC OR 4-20 mA.
- 15 WIRE TO CUSTOMER COMPRESSOR % RLA OUTPUT 2-10 VDC OR 4-20 mA.
- 16 ALL CUSTOMER CONTROL CIRCUIT WIRING MUST BE COPPER CONDUCTORS ONLY AND HAVE A MINIMUM INSULATION RATING OF 300 VOLTS. EXCEPT AS NOTED, ALL CUSTOMER WIRING CONNECTIONS ARE MADE TO CIRCUIT BOARD MOUNTED BOX LUGS WITH A WIRE RANGE OF 14 TO 18 AWG OR DIN RAIL MOUNTED SPRING FORCE TERMINALS.
- 17 UNIT PROVIDED DRY CONTACTS FOR THE CONDENSER/CHILLED WATER PUMP CONTROL. RELAYS ARE RATED FOR 7.2 AMPS RESISTIVE, 2.88 AMPS PILOT DUTY, OR 1/3 HP, 7.2 FLA AT 120 VOLTS 60 HZ. CONTACTS ARE RATED FOR 5 AMPS GENERAL PURPOSE DUTY 240 VOLTS.
- 18 CUSTOMER SUPPLIED CONTACTS FOR ALL LOW VOLTAGE CONNECTIONS MUST BE COMPATABLE WITH DRY CIRCUIT 24 VOLTS DC FOR A 12 mA RESISTIVE LOAD. SILVER OR GOLD PLATED CONTACTS RECOMMENDED.
- 19 THE CONTACTS FOR AUTO STOP AND EMERGENCY STOP SWITCHES ARE JUMPERED AT THE FACTORY BY JUMPERS 1W1 & 1W2 TO ENABLE UNIT OPERATION. IF REMOTE CONTROL IS DESIRED, REMOVED THE JUMPERS AND CONNECT TO THE DESIRED CONTROL CIRCUIT.
20. SOLID OVALS REPRESENT MAX NUMBER OF CONDUITS AND/OR CABLE GLANDS USED.
- 21 CONNECTIONS ARE INTENDED FOR CLASS 2 ONLY.
- 22 CIRCUIT 3 REQUIRES 15A PROTECTION AT 120V, 8A AT 220V.
- 23 CIRCUIT 4 REQUIRES 20A PROTECTION.
- 24 USED WHEN SUPPLIED VOLTAGE IS 380V-460V.
- 25 USED WHEN SUPPLIED VOLTAGE IS 200V-230V OR 575V.

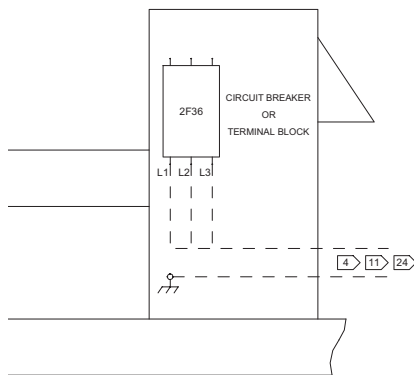



Dimensions and Weights

Unit Length

Units are EXTENDED length if either of the following are selected:

- Transformer: Model number digit 28 = 1
- Harmonic Filtration Option: Model number digit 29 = 1

Units without Harmonic Filtration Option or Transformer (digits 28, 29 = 0X) are STANDARD length.

Weights

Table 7. Weights

Unit Size (tons)	Standard Length Unit				Extended Length Unit ^(a)			
	Shipping		Operating		Shipping		Operating	
	lbs	kg	lbs	kg	lbs	kg	lbs	kg
InvisiSound™ Standard or Superior^(b)								
150S	9436	4280	9596	4353	11013	4995	11173	5068
165S	10451	4741	10611	4813	12011	5448	12171	5521
150	11333	5141	11479	5207	13492	6120	13638	6186
165	12377	5614	12533	5685	14532	6592	14688	6662
180	12698	5760	12880	5843	14853	6737	15035	6820
200	13808	6263	14007	6354	15991	7254	16213	7354
225	15244	6915	15466	7015	17427	7905	17649	8005
250	15622	7086	15861	7195	17805	8076	18044	8185
275	16820	7630	17095	7754	18975	8607	19250	8732
300	17965	8149	18265	8285	20121	9127	20421	9263
InvisiSound Ultimate^(c)								
150S	10236	4643	10396	4716	11813	5358	11973	5431
165S	11251	5103	11411	5176	12811	5811	12971	5884
150	12133	5504	12279	5570	14292	6483	14438	6549
165	13177	5977	13333	6048	15332	6955	15488	7025
180	13498	6123	13680	6205	15653	7100	15835	7183
200	14608	6626	14807	6716	16791	7616	17013	7717
225	16044	7278	16266	7378	18227	8268	18449	8368
250	16422	7449	16661	7557	18605	8439	18844	8548
275	17620	7992	17895	8117	19775	8970	20050	9095
300	18765	8512	19065	8648	20921	9490	21221	9626

(a) Units are extended length if either of the following are selected:
 Transformer (model number digit 28 = 1)
 Harmonic Filtration Option (model number digit 29 = 1)
 Units without Harmonic Filtration Option or Transformer (digits 28, 29 = 0X) are standard length.
 (b) Model number digit 12 = 1 or 2
 (c) Model number digit 12 = 3

Service Clearance

Figure 13. RTAE service clearances

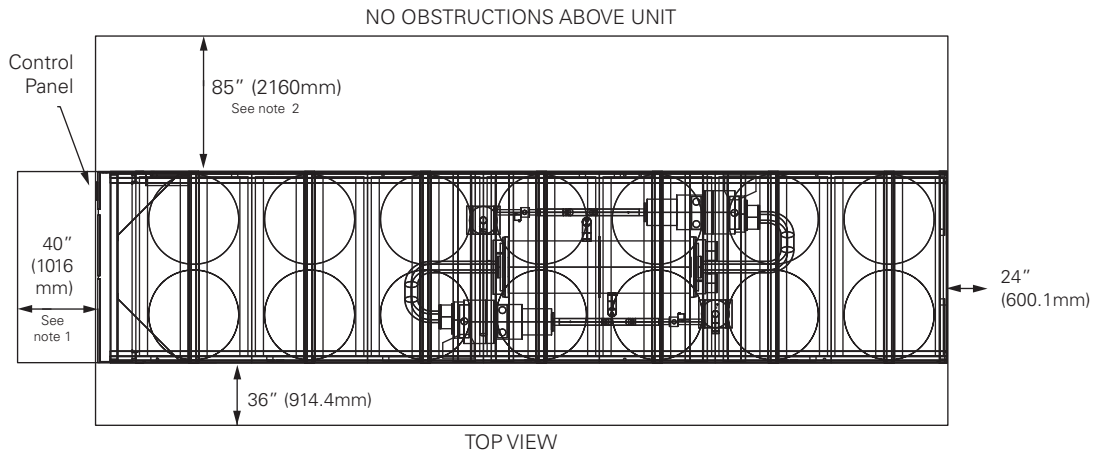

NOTES:

1. A full 40" clearance is required in front of the control panel. Must be measured from front of panel, not end of unit base.
2. Clearance of 85" on the side of the unit is required for coil replacement. Preferred side for coil replacement is shown (left side of unit, as facing control panel), however either side is acceptable.

Dimensions

Standard Length Units

- See "Unit Length," p. 38 to determine unit length. See "Extended Length Unit Dimensions," p. 47 for right side dimensions of extended length units.
- See "3-Pass Evaporator Dimensions," p. 53 for 3-pass option changes.

Figure 14. 150 ton single circuit – 380, 400 or 575V

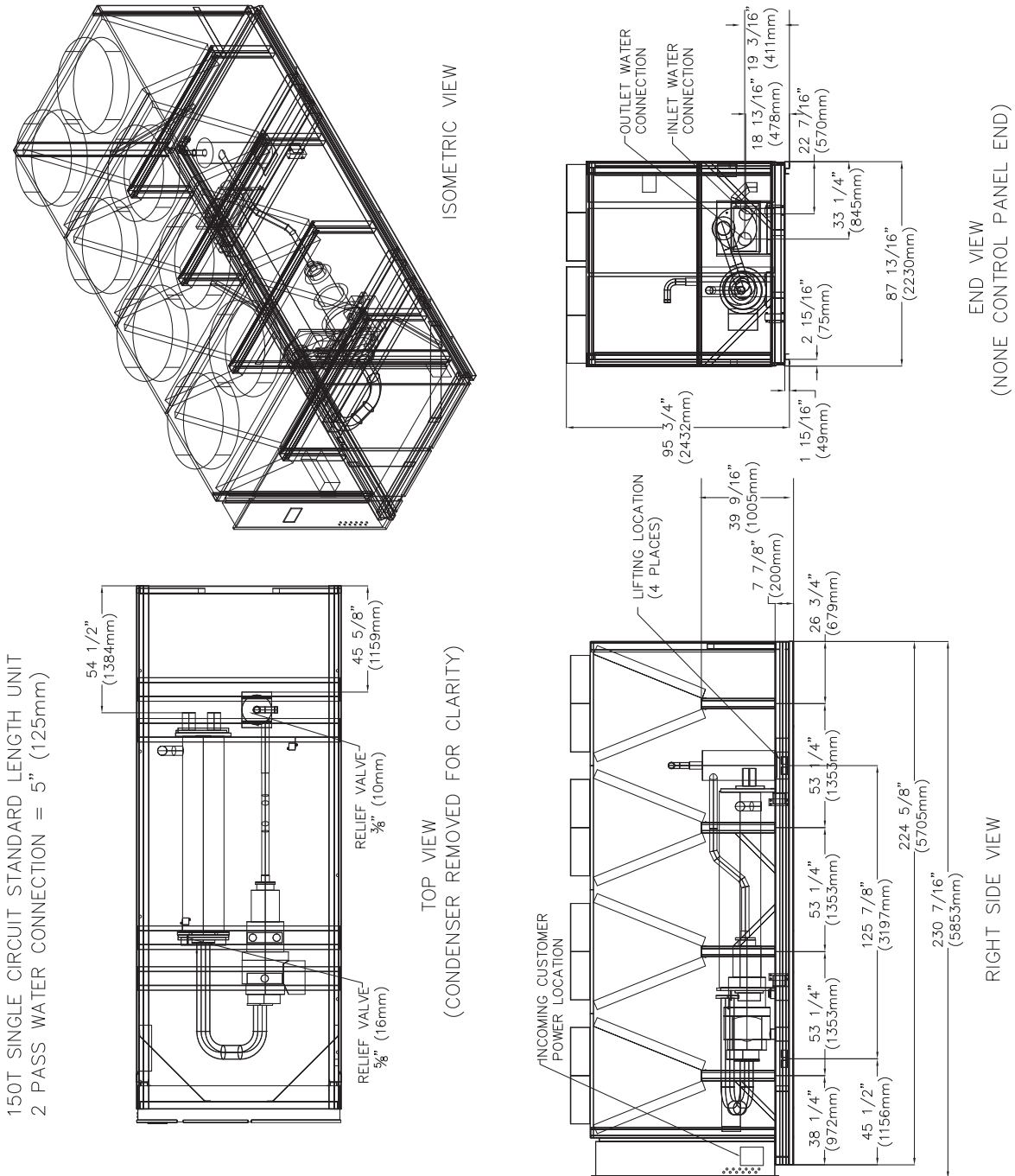
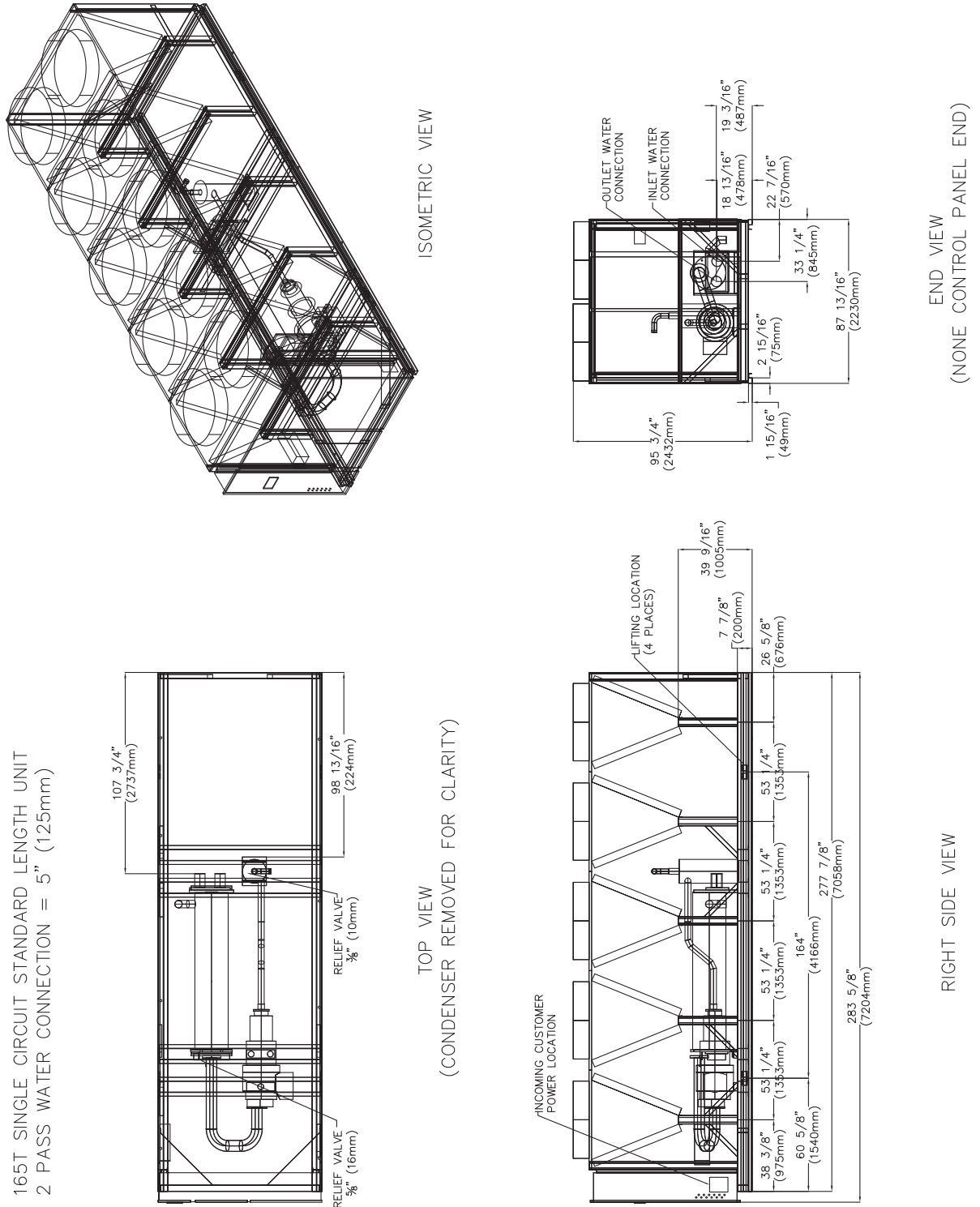

Figure 15. 165 ton single circuit – 380, 400 or 575V



Dimensions and Weights

Figure 16. 150 ton

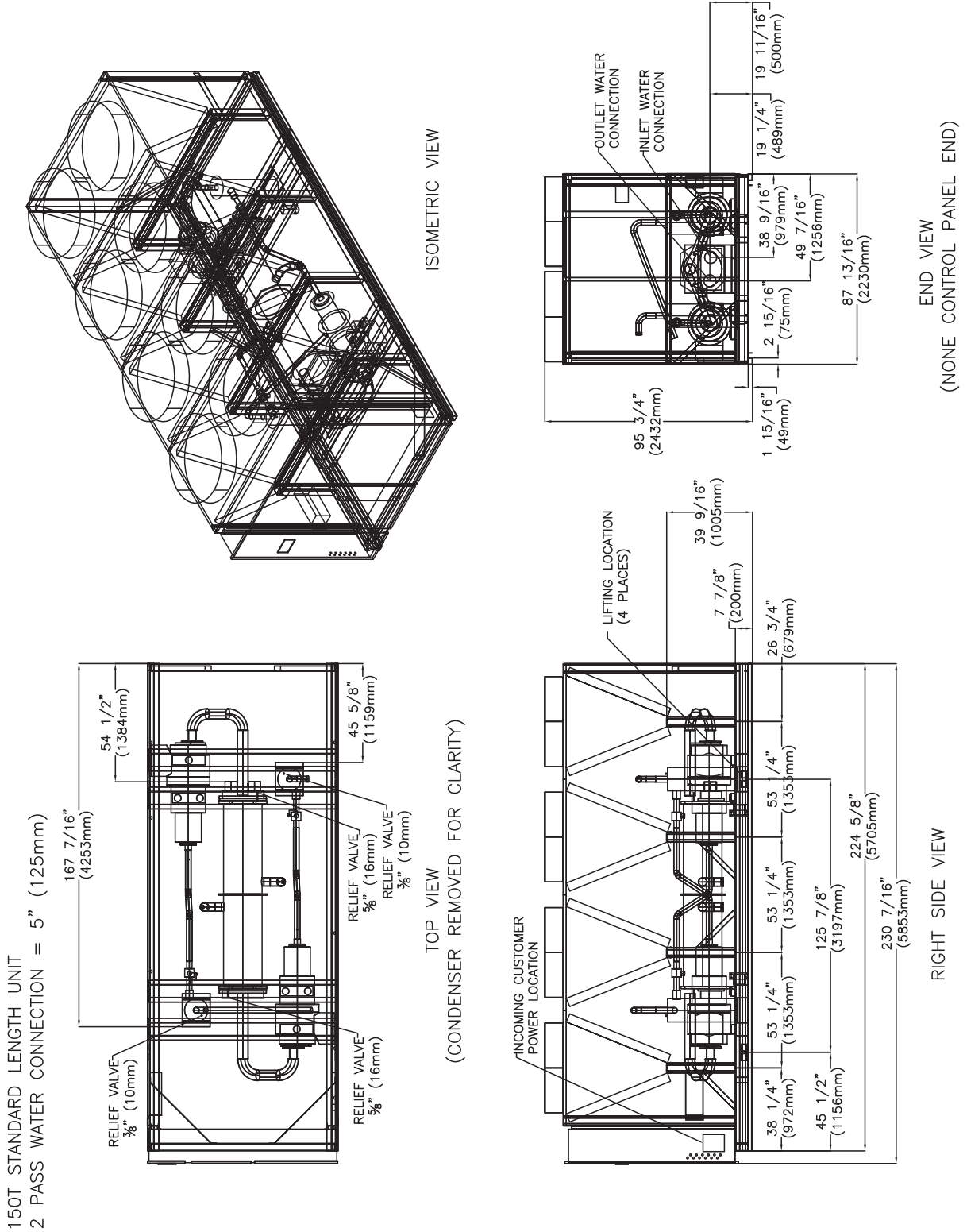
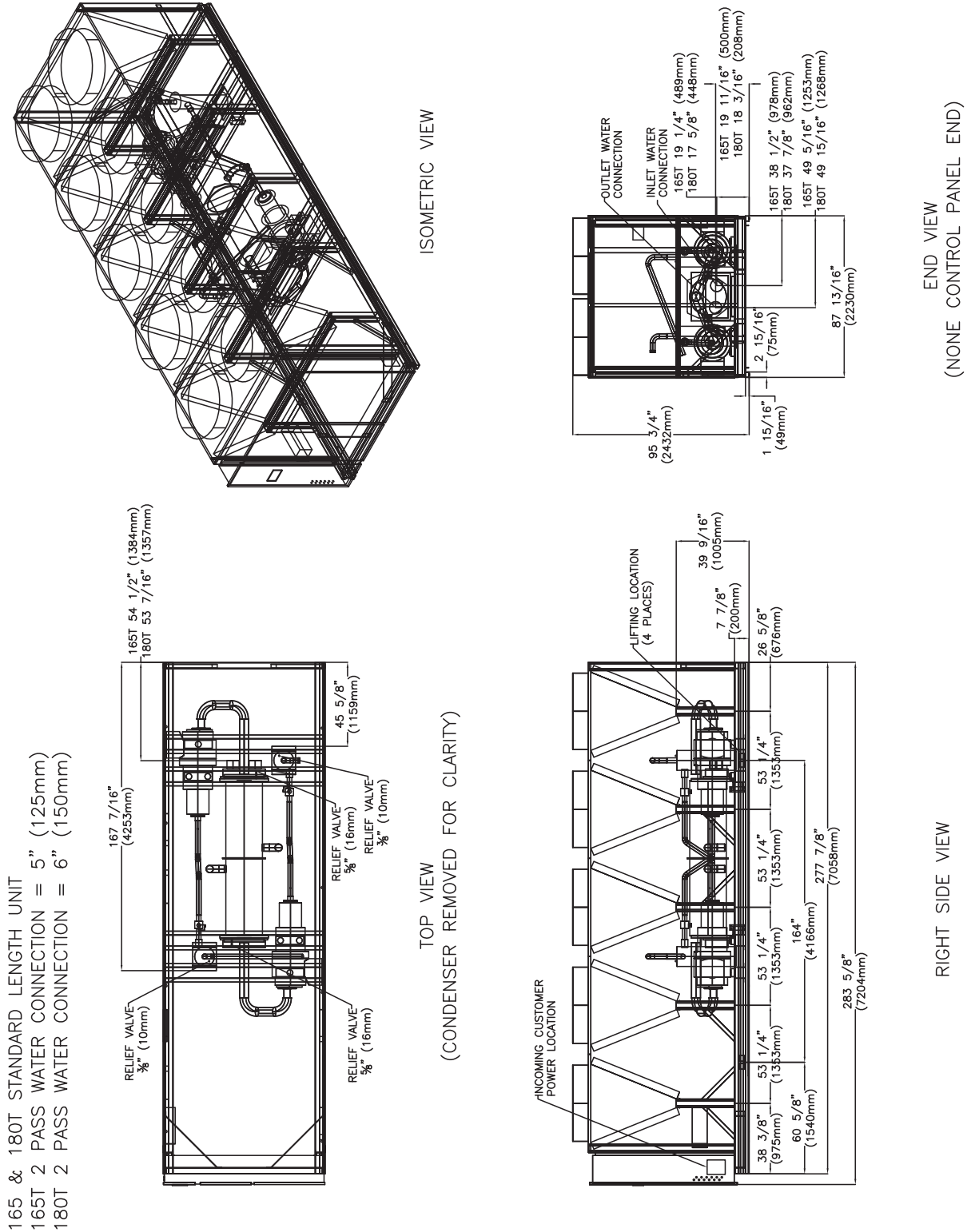

Figure 17. 165-180 ton



Dimensions and Weights

Figure 18. 200-250 ton

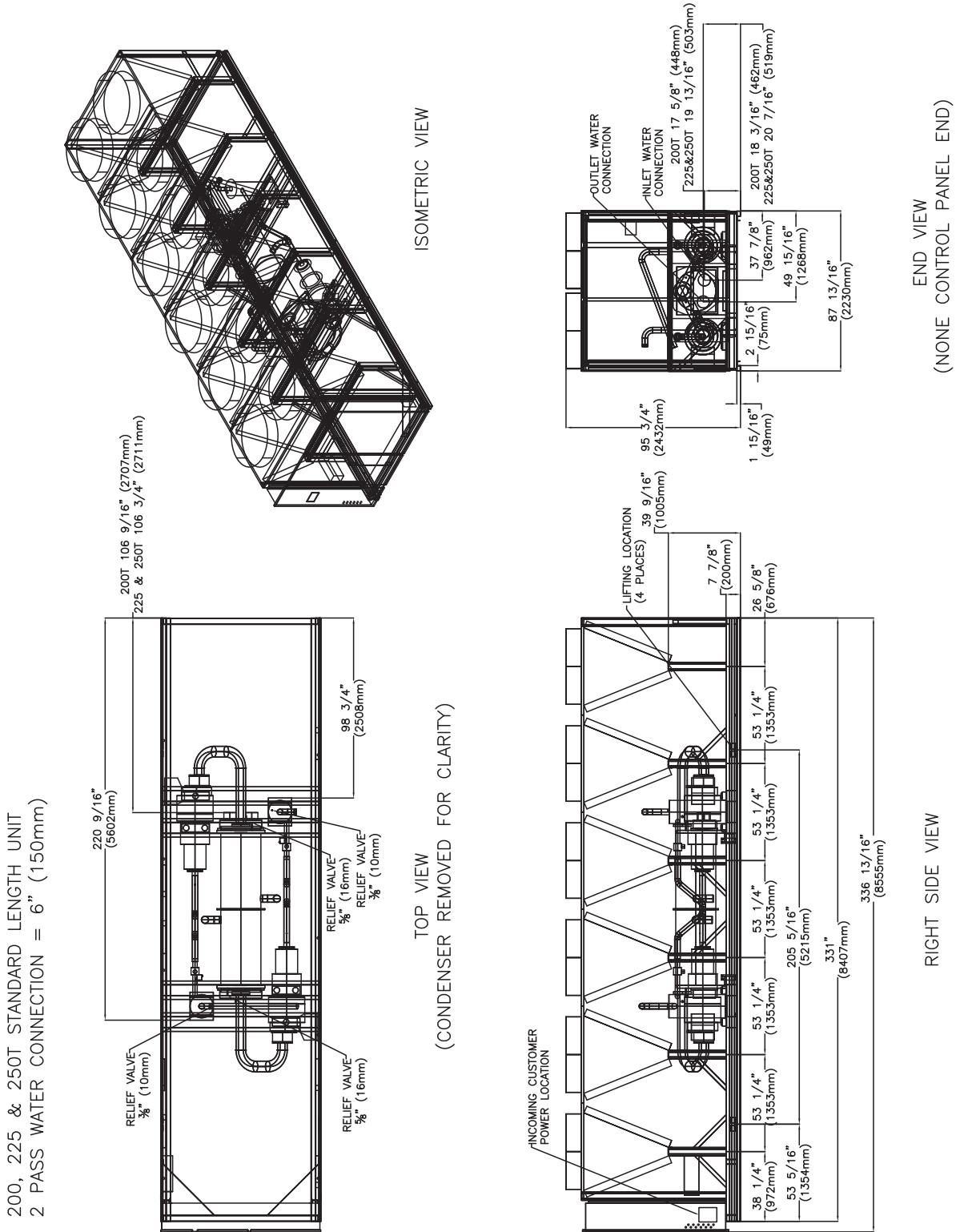
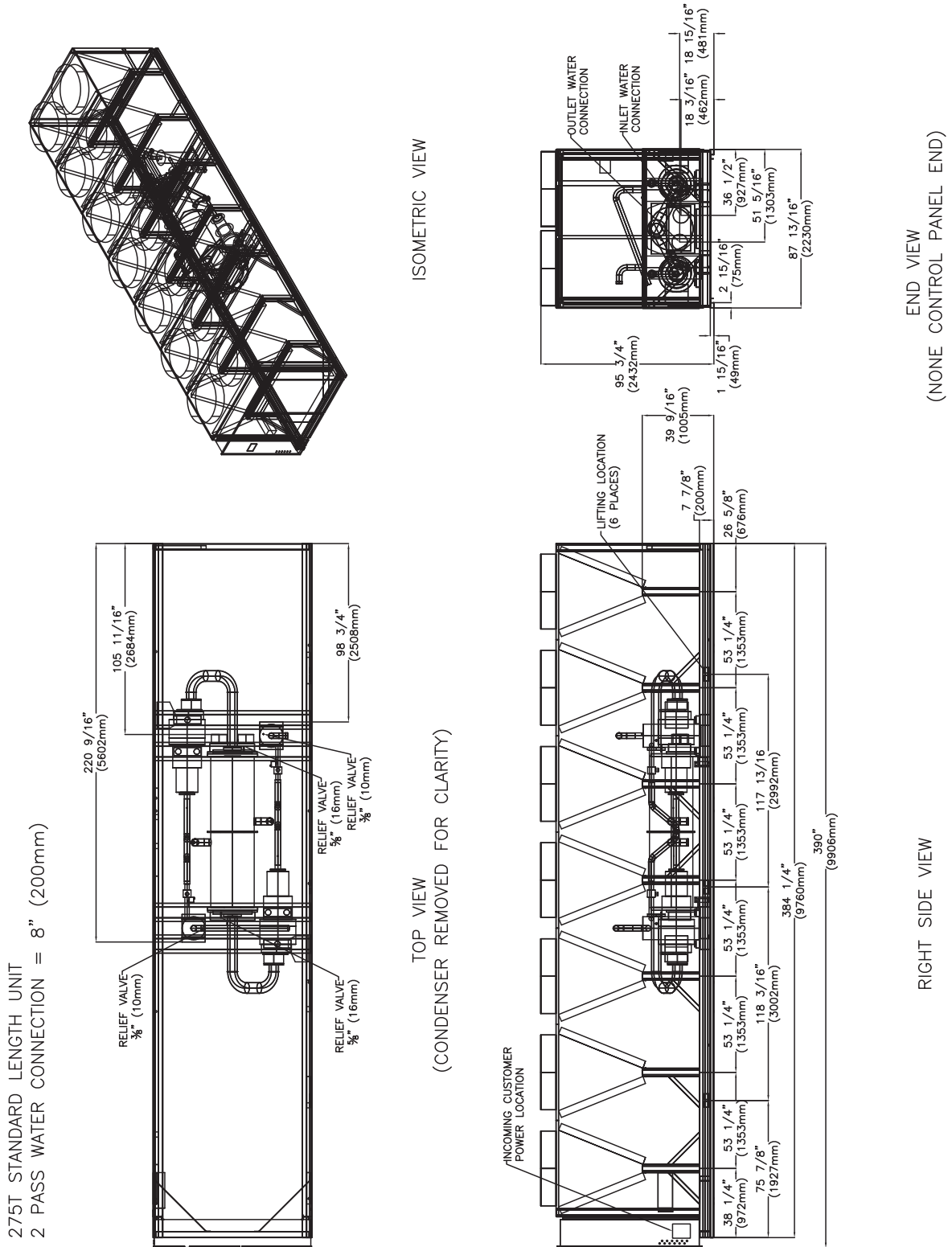
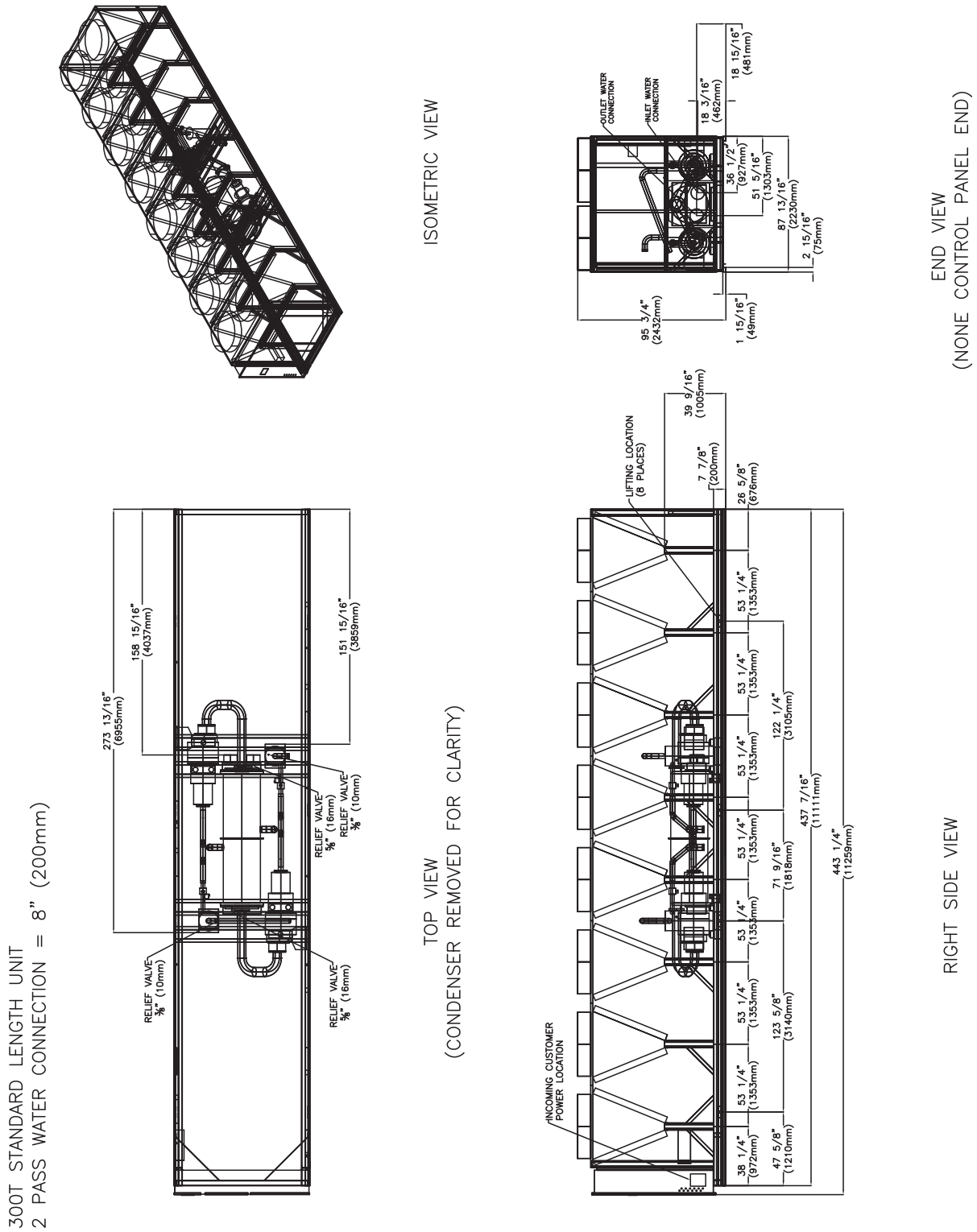

Figure 19. 275 ton



Dimensions and Weights

Figure 20. 300 ton



Extended Length Unit Dimensions

Note: Top and end view dimensions are the same as the standard length units. See "Standard Length Units," p. 40 for these dimensions.

Figure 21. 150 ton single circuit with transformer option (200, 230 or 575V) — right side view

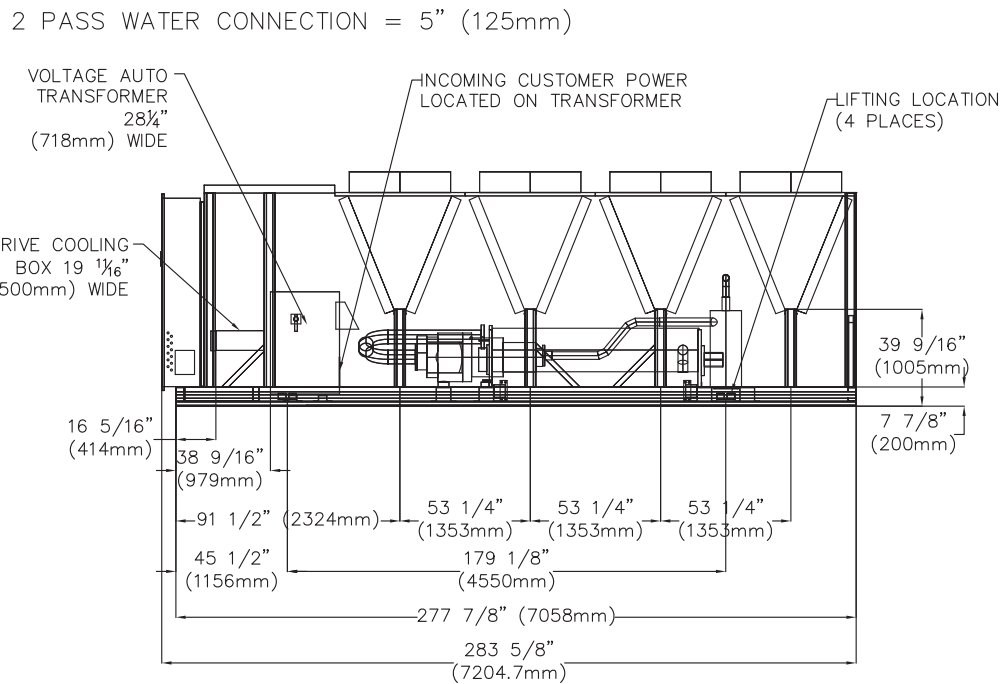
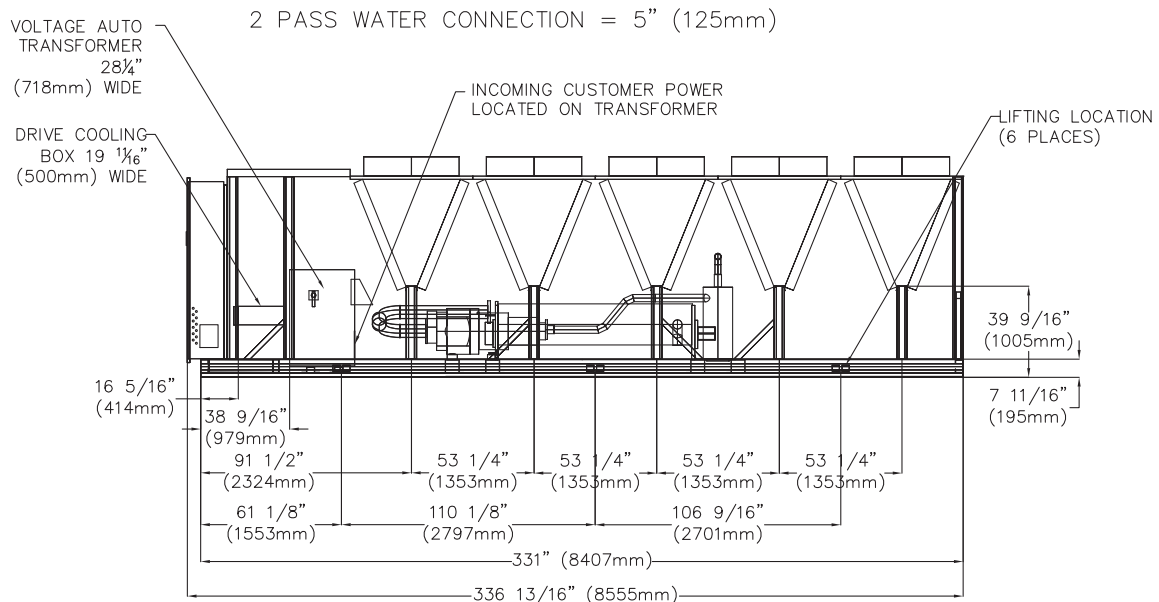

Figure 22. 165 ton single circuit with transformer option (200, 230 or 575V) — right side view



Dimensions and Weights

Figure 23. 150 ton with harmonic filtration option — right side view

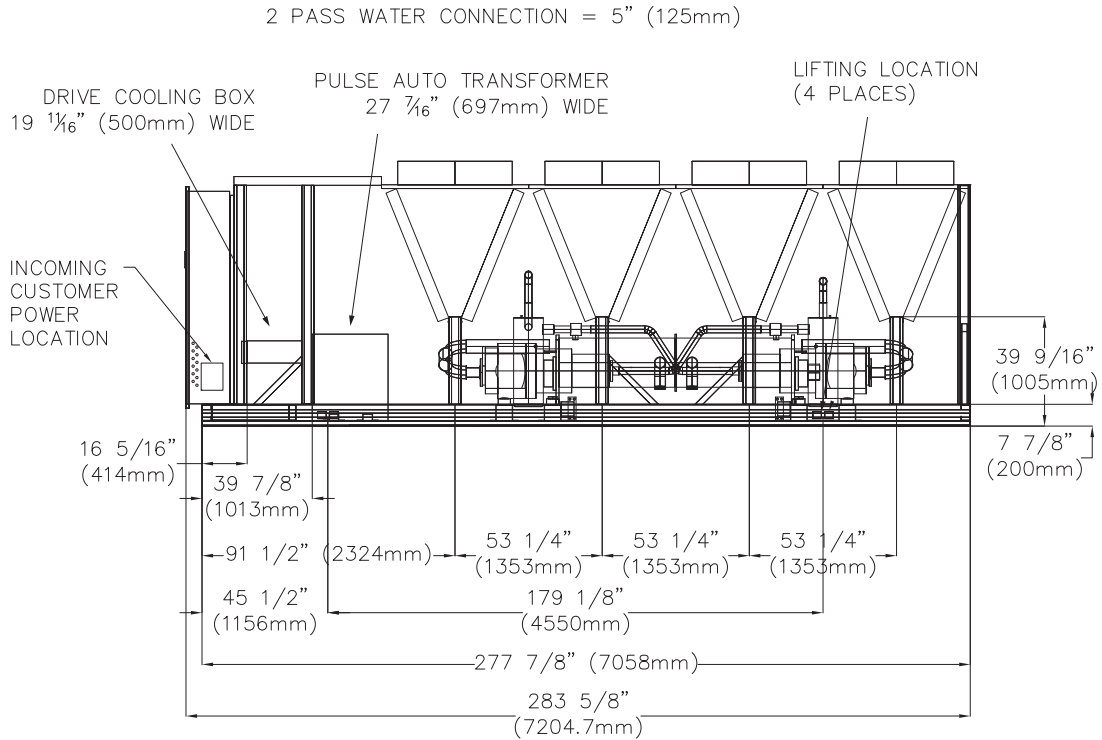

Figure 24. 150 ton with transformer option (200, 230 or 575V) — right side view

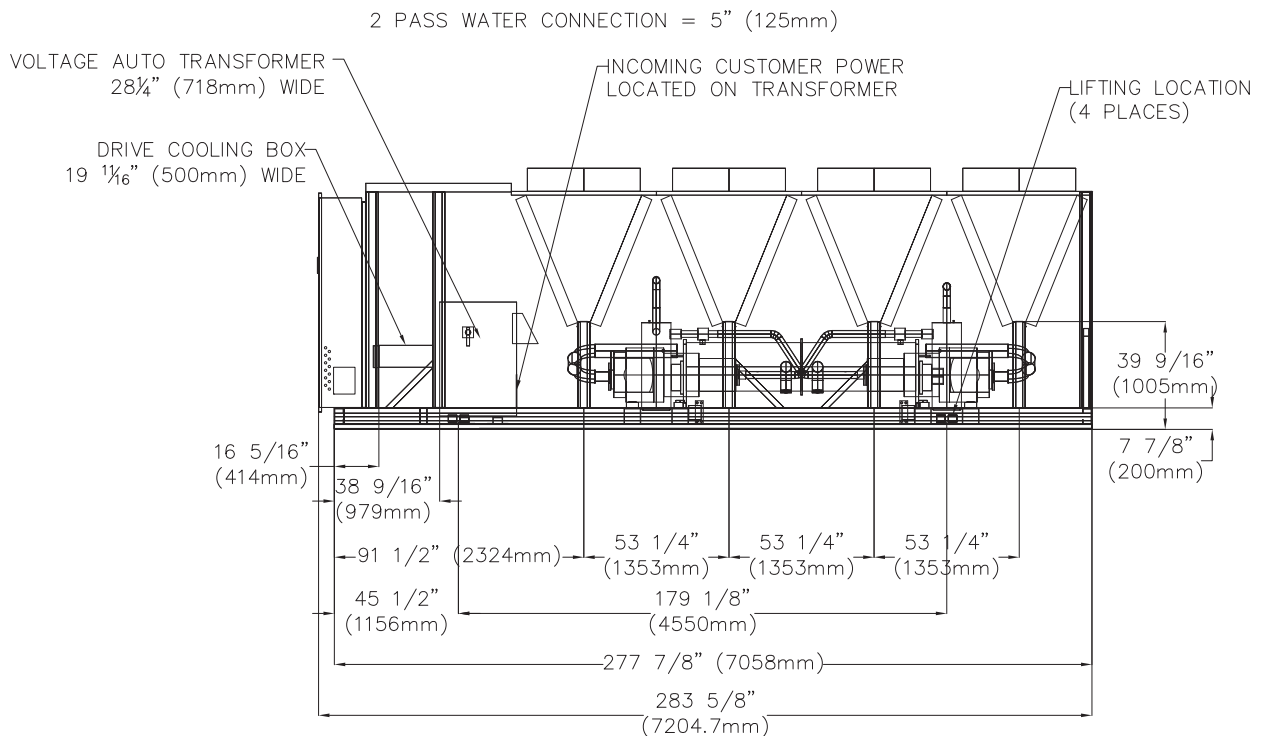

Figure 25. 165 - 180 ton with harmonic filtration option – right side view

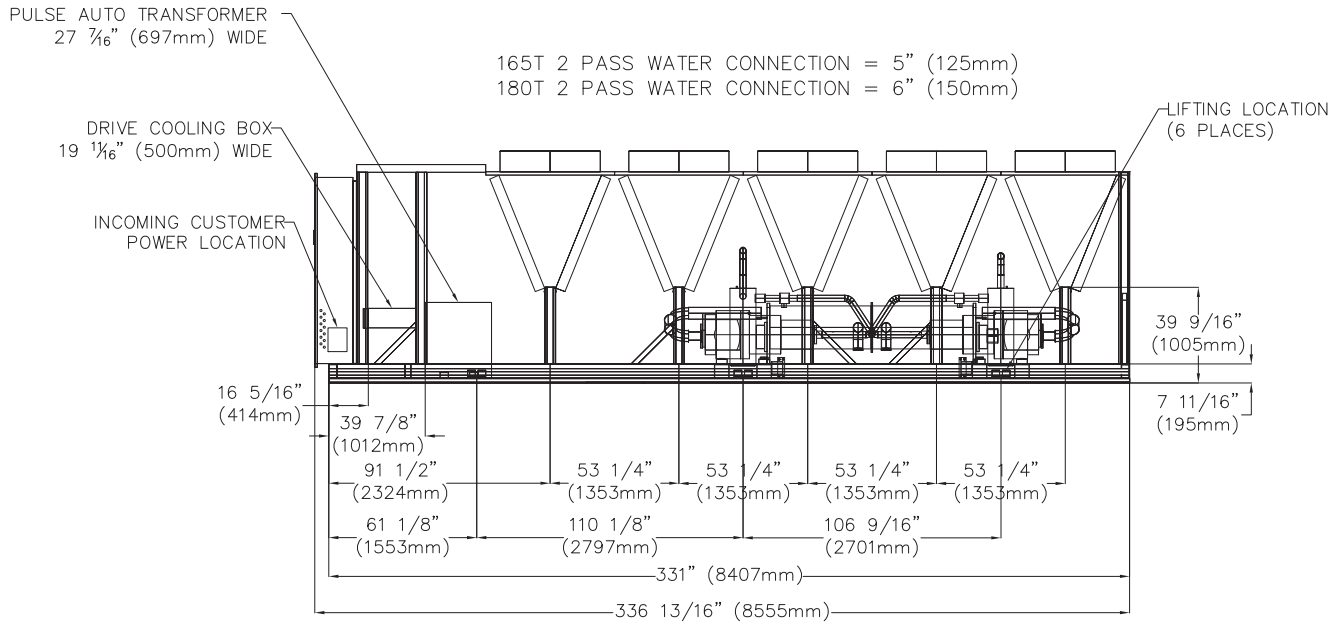
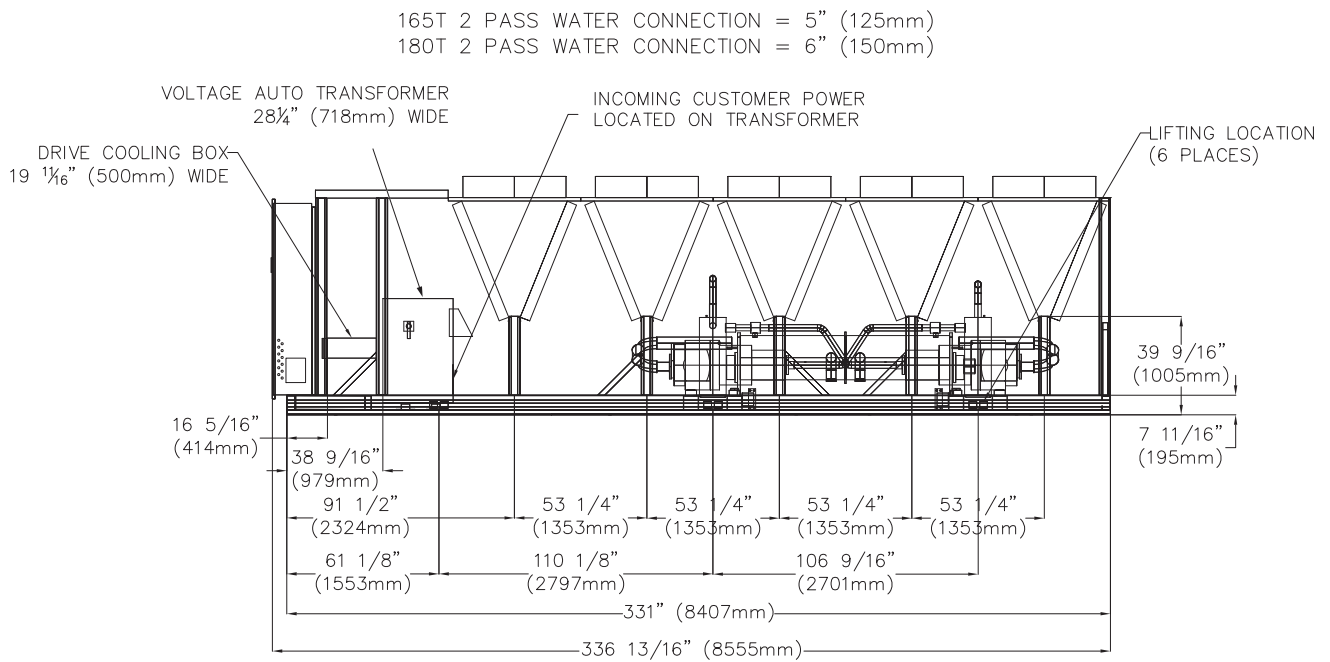

Figure 26. 165 - 180 ton with transformer option (200, 230 or 575V) – right side view



Dimensions and Weights

Figure 27. 200 - 250 ton with harmonic filtration option – right side view

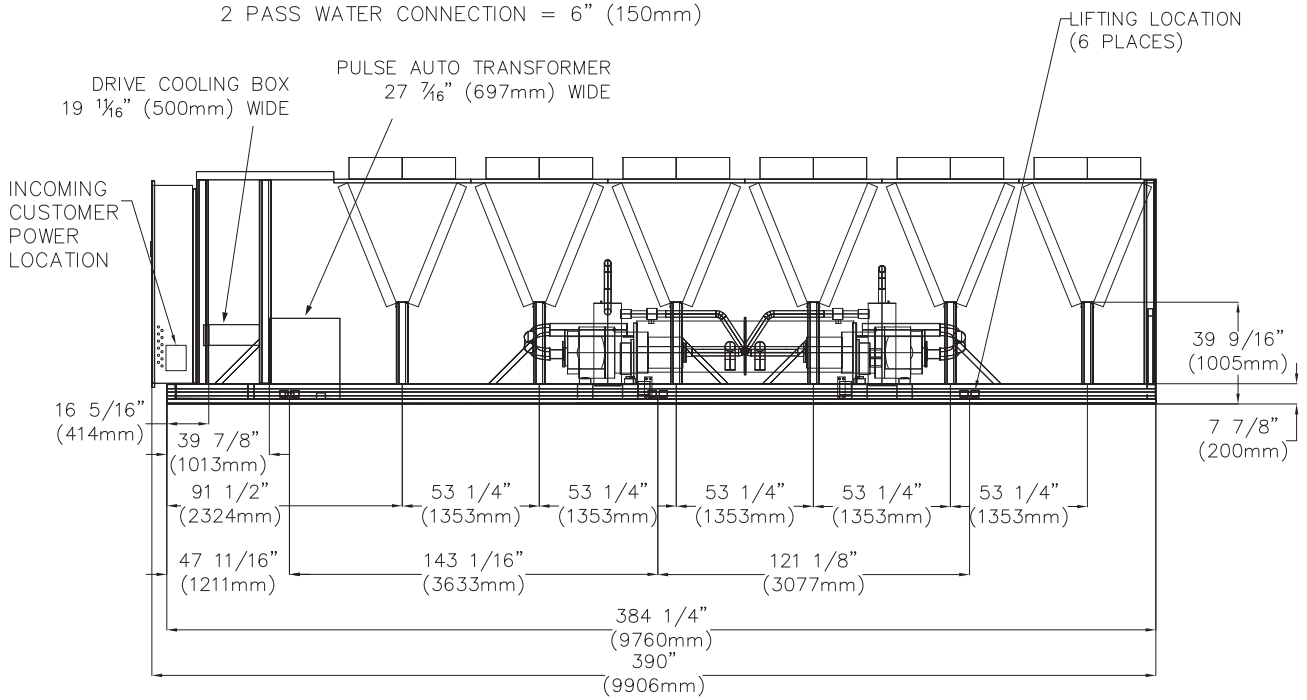

Figure 28. 200 - 250 ton with transformer option (200, 230 or 575V) – right side view

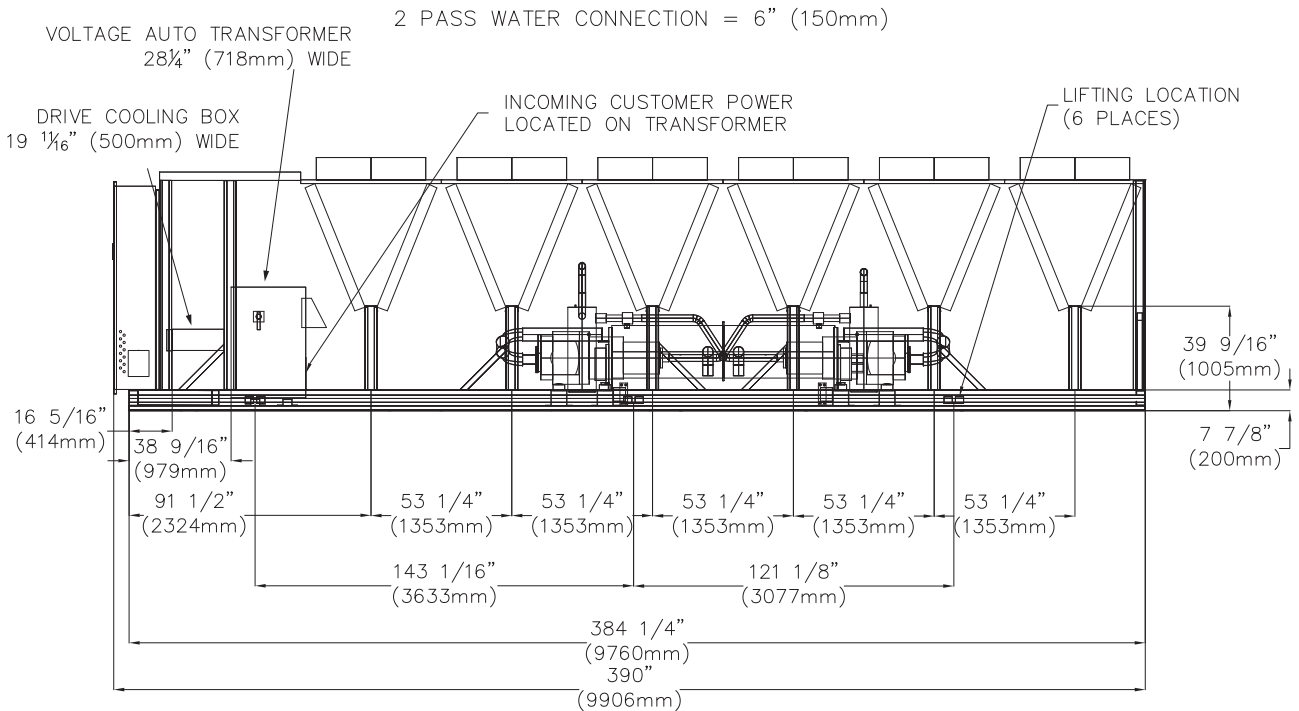

Figure 29. 275 ton with harmonic filtration option — right side view

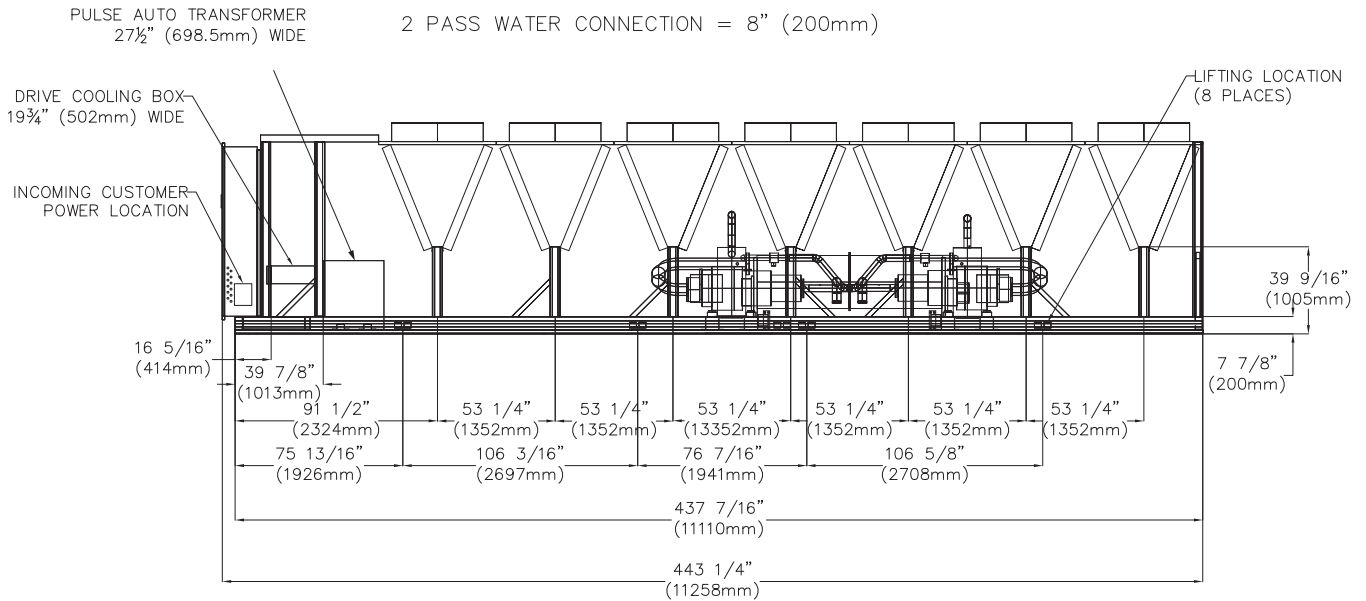
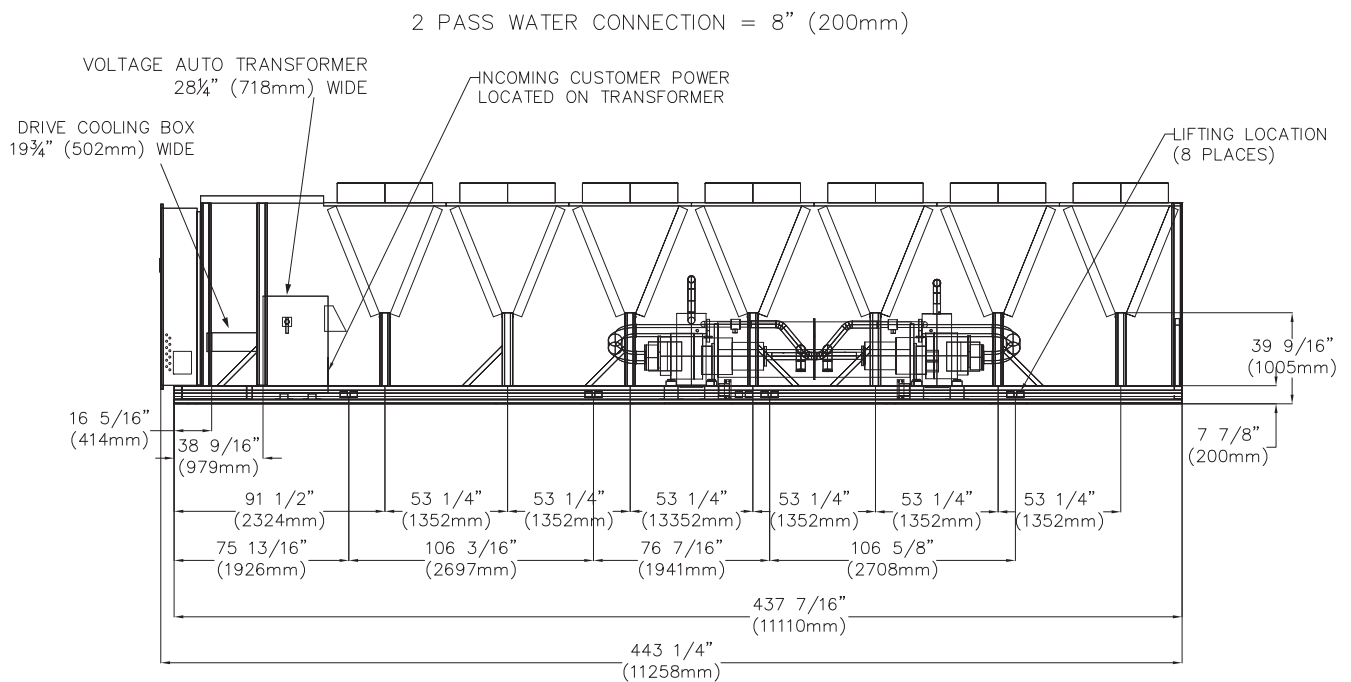

Figure 30. 275 ton with transformer option (200, 230 or 575V) — right side view



Dimensions and Weights

Figure 31. 300 ton with harmonic filtration option — right side view

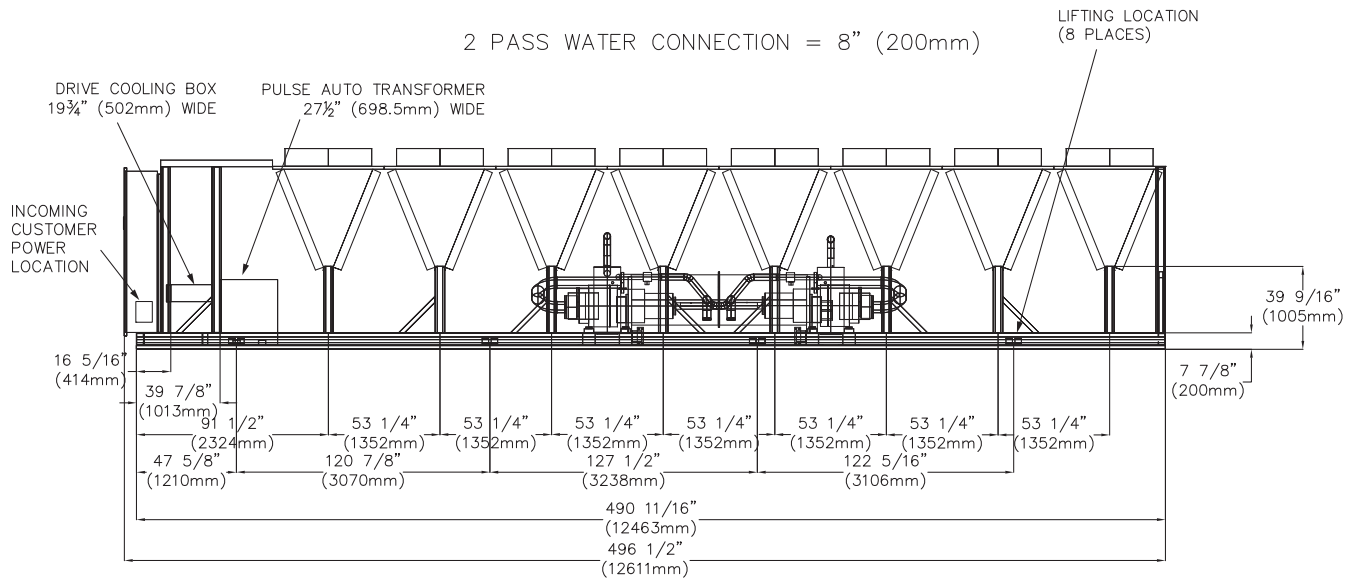
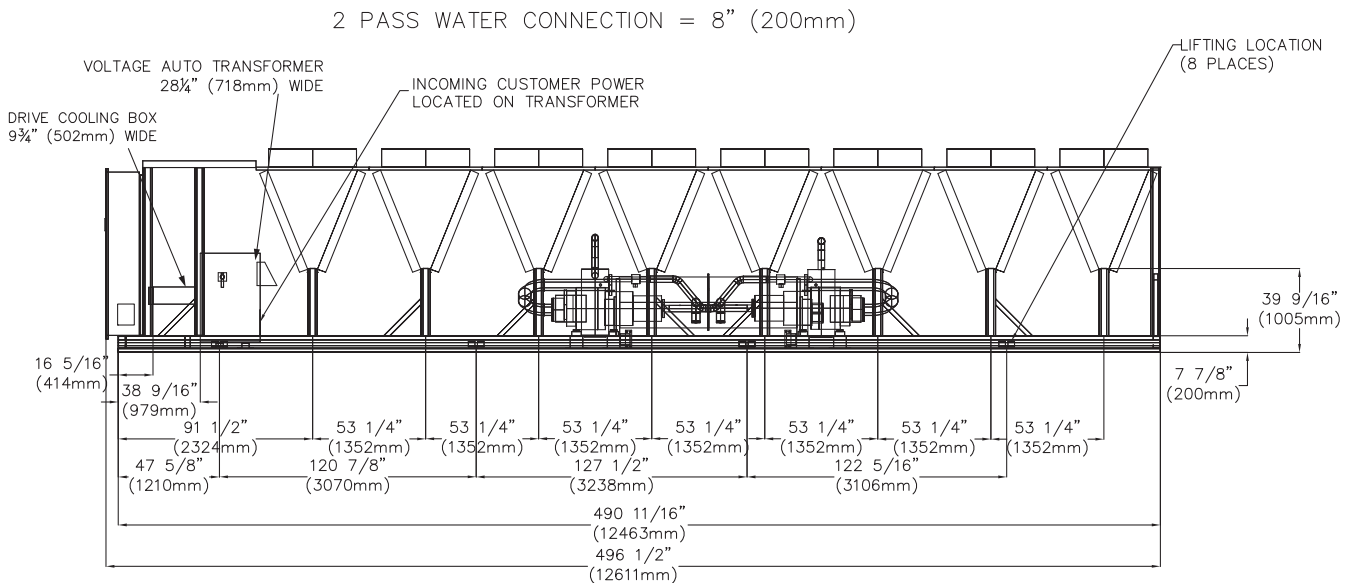
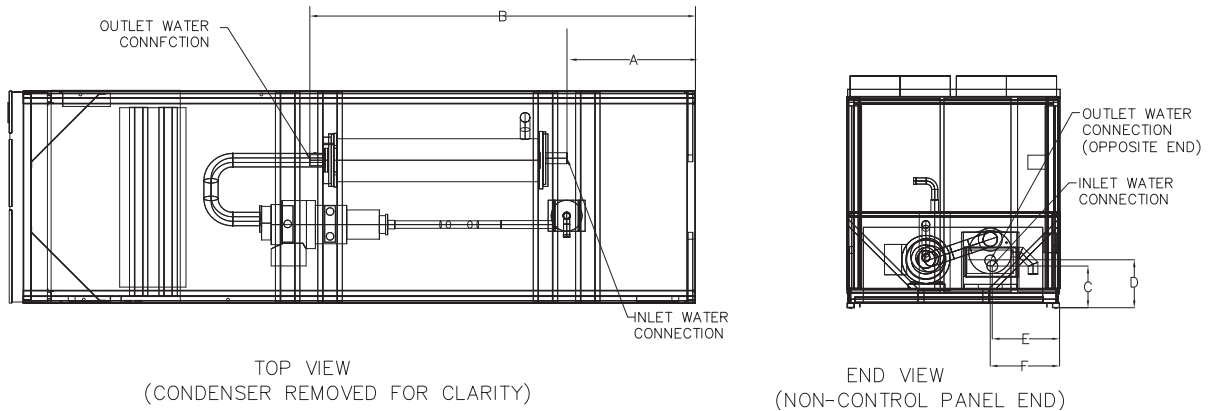

Figure 32. 300 ton with transformer option (200, 230 or 575V) — right side view



3-Pass Evaporator Dimensions

Figure 33. 3 pass evaporator^(a) — single circuit units



(a) See Table 8 for corresponding dimension values.

Figure 34. 3 pass evaporator^(a) — dual circuit units

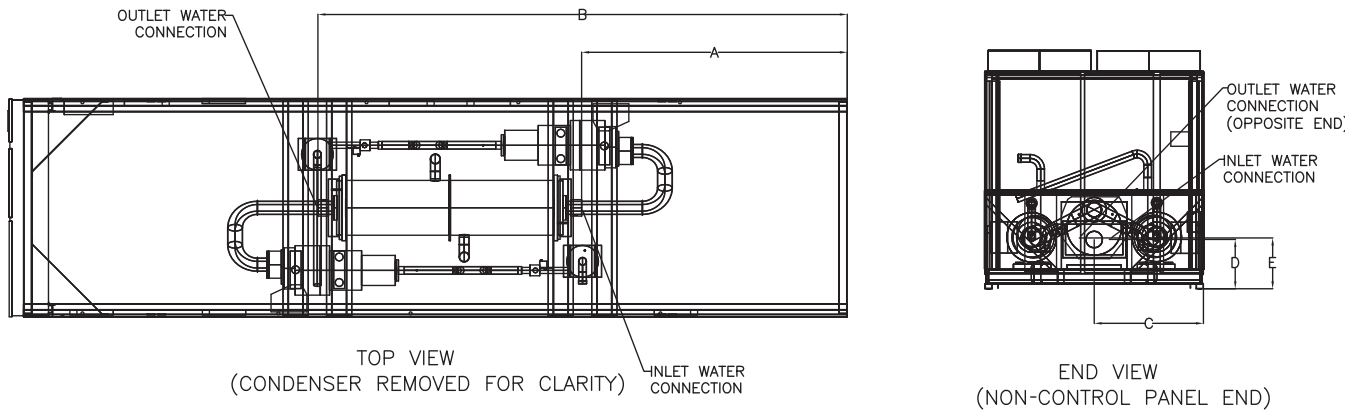

(a) See Table 8 for corresponding dimension values.

Table 8. 3-pass evaporator dimensions^(a)

Dim	Unit size (tons)															
	150S		165S		150, 165		180		200		225, 250		275		300	
	in	mm	in	mm	in	mm	in	mm	in	mm	in	mm	in	mm	in	mm
A	15.0625	1348	106.3125	200	53.25	1353	51.50	1308	104.63	2657	104.81	2662	104.56	2656	157.75	4007
B	159.375	4048	212.625	5401	159.44	4050	160.38	4074	213.50	5423	213.69	5428	213.63	5426	266.19	6761
C	17.25	438	17.25	438	44.00	1118	44.00	1118	44.00	1118	44.00	1118	44.00	1118	44.00	1118
D	19.5	495	19.5	495	17.69	449	15.38	391	15.38	391	17.56	446	16.06	408	16.06	408
E	27.8125	706	27.8125	706	20.44	519	19.56	497	19.56	497	21.81	554	20.56	522	20.56	522
F	28.625	727	28.625	727	-	-	-	-	-	-	-	-	-	-	-	-
Water Conn	4	100	4	100	4	100	5	125	5	125	5	125	6	150	6	150

(a) See Figure 33 and Figure 34 for corresponding unit graphics.



Mechanical Specifications

General

Units are leak and pressure tested at 390 psig high side, 250 psig low side, then evacuated and charged. All Stealth™ RTAE Chillers are factory tested prior to shipment. Packaged units ship with a full operating charge of oil and refrigerant as standard. Units can also be shipped with a nitrogen charge if required. Unit panels, structural elements and control boxes are constructed of galvanized steel and mounted on a bolted galvanized steel base. Unit panels, control boxes and the structural base are finished with a baked on powder paint. All paint meets the requirement for outdoor equipment of the US Navy and other federal government agencies.

Refrigeration Circuits

All Stealth chiller sizes are available with two refrigerant circuits. For 150T and 165T units, a single refrigeration circuit option is available.

Each refrigeration circuit includes one rotary screw compressor, a compressor suction and discharge service valve, liquid line shutoff valve, removable core filter, liquid line sight glass with moisture indicator, charging port and an electronic expansion valve. Fully modulating compressors and electronic expansion valves provide variable capacity modulation over the entire operating range.

Evaporator

The evaporator is a tube-in-shell heat exchanger design constructed from carbon steel shells and tubesheets with internally and externally finned seamless copper tubes mechanically expanded into the tube sheets. The evaporator is designed, tested and stamped in accordance with the ASME Boiler and Pressure Vessel Code for a refrigerant side working pressure of 200 psig. The evaporator is designed for a water side working pressure of 150 psig. Standard water connections are grooved for Victaulic style pipe couplings, with groove to flange style adapters available. Waterboxes are available in 2 and 3 pass configurations and include a vent, a drain and fittings for temperature control sensors. Evaporators are insulated with 3/4 inch closed cell insulation. Evaporator water heaters with thermostat are provided to help protect the evaporator from freezing at ambient temperatures down to -20°F (-29°C). A factory installed flow switch is installed on the supply water box in the evaporator inlet connection.

Condenser and Fans

Air-cooled condenser coils have aluminum fins mechanically bonded to internally finned seamless aluminum tubing. The tubing is a long life alloy designed to deliver corrosion performance that meets or exceeds microchannel coils. The condenser coil has an integral subcooling circuit. Condensers are factory proof tested at 525 psig and leak tested with helium in a mass spectrometer chamber at 150 psig. All tube connections are mechanical except the brazed copper to aluminum inlet and outlet connections. The copper to aluminum connections are protected against galvanic corrosion. Corrosion resistant coil coating is available if the installation site is near the ocean or in an otherwise corrosive environment. See ["Options," p. 57](#).

Condenser fans are direct-drive vertical discharge. The condenser fan motors are permanent magnet motors with integrated drive to provide variable speed fan control for all fans and are designed with permanently lubricated ball bearings, internal temperature and current overload protection, and customer fault feedback as a standard product offering. The fan impeller is a nine bladed-shrouded fan made from heavy-duty molded plastic.

Compressor and Lube Oil System

The rotary screw compressor is semi-hermetic, direct drive with capacity control via a variable speed drive, rolling element bearings, differential refrigerant pressure oil flow and oil heater. The

motor is a suction gas cooled, hermetically sealed, permanent magnet motor. An oil separator is provided separate from the compressor. Oil filtration is provided internal to the compressor.

Drive Cooling System

Each refrigeration circuit has a compressor drive cooling circuit. Each drive cooling circuit includes a wet rotor circulation pump that circulates a secondary heat transfer fluid in a closed system between the adaptive frequency drive components in the control panel and a brazed plate heat exchanger. The pump is fed from a thermal expansion tank with a vented-pressure cap which is also used as the circuit pressure relief. Pressure relief for the drive cooling loop is set at 16 psig. The circuit also includes a particulate strainer and a drain valve for servicing.

Tracer AdaptiView TD7 Display

- Outdoor capable:
 - UV Resistant Touchscreen
 - -40C to 70C Operating Temperature
 - IP56 rated (Power Jets of Water from all directions)
- RoHS Compliant
- UL 916 Listed
- CE Certification
- Emissions: EN55011 (Class B)
- Immunity: EN61000 (Industrial)
- Display:
 - 7" diagonal
 - 800x480 pixels
 - TFT LCD @ 600 nits brightness
 - 16 bit color graphic display
- Display Features:
 - Alarms
 - Reports
 - Chiller Settings
 - Display Settings
 - Graphing
 - Global Application
 - Support for 26 Languages

Unit Controls

All unit controls are housed in an outdoor rated weather tight enclosure with removable plates to allow for customer connection of power wiring and remote interlocks. All controls, including sensors, are factory mounted and tested prior to shipment. Microcomputer controls provide all control functions including startup and shut down, leaving chilled water temperature control, evaporator flow proving, compressor staging and speed control, electronic expansion valve modulation, condenser fan sequencing and speed control, anti-recycle logic, automatic lead/lag compressor starting and load limiting.

Mechanical Specifications

The Tracer™ UC800 unit control module, utilizing Adaptive Control™ microprocessor, automatically takes action to avoid unit shut-down due to abnormal operating conditions associated with low refrigerant pressure, high condensing pressure, AFD/Compressor current overload, low oil return or low AFD cooling, low discharge superheat, and high compressor discharge temperature. Should the abnormal operating condition continue until a protective limit is violated, the unit will be shut down. Unit protective functions of the UC800, include loss of chilled water flow, evaporator freezing, loss of refrigerant, low refrigerant pressure, high refrigerant pressure, high compressor motor temperature, and loss of oil to the compressor.

A full color Tracer AdaptiView™ TD7 touch screen display indicates all important unit and circuit parameters, in logical groupings on various screens. The parameters including chilled water set point, leaving chilled water temperature, demand limit set point, evaporator and condenser refrigerant temperatures and pressures, compressor and fan speeds, and all pertinent electrical information. The display also provides “on screen” trending graphs of predefined parameters as well as customizable trend graphs based on user defined parameters from a list of all available parameters. The display also provides indication of the chiller and circuits’ top level operating modes with detailed sub-mode reports available with a single key press, as well as diagnostics annunciation and date and time stamped diagnostic history. The color display is fully outdoor rated, and, can be viewed in full daylight without opening any control panel doors.

Standard power connections include main three phase power to the compressors, condenser fans and control power transformer and optional connections are available for the 115 volt/60 Hz single phase power for the thermostatically controlled evaporator heaters for freeze protection.

Adaptive Frequency Drive

All RTAE chillers utilize Trane’s Adaptive Frequency™ Drive, 3rd Generation (AFD₃) technology for controlling the compressors. AFD₃ is a family of new generation adaptive frequency drives specifically designed for Trane water chillers. AFD₃ incorporates the Trane communication protocol enabling seamless integration with the unit controller. AFD₃ data such as drive status, temperatures, modes and diagnostic information are accessible to the unit controller and through the Tracer TU service tool.

AFD₃ contains technology that enables the drive to last the life time of the chiller and with less down time. The technology enables operation on various power systems including alternative energy sources. AFD₃ will protect itself and the compressor motor from over current, low or high line voltage, phase loss, incoming phase imbalance, and over temperature due to loss of drive cooling or loss of panel ventilation.

AFD₃ incorporates improved serviceability and troubleshooting tools to identify the issue quickly and get the chiller back up and running. All AFD₃ control circuits are powered with class 2 low voltage —separate from main power allowing service on the controls with the panel door open. Additionally, the main electronic control modules can be serviced with the standard Trane screw driver. The AFD₃ further incorporates another Trane service tool to allow for firmware upgrades through Tracer TU.

Chilled Water Reset

This provides the control logic and factory installed sensors to reset leaving chilled water temperature. The set point can be reset based on ambient temperature or return evaporator water temperature.

Factory Mounted Flow Proving and Flow Control

The factory installed evaporator water flow switch is provided with the control logic and relays to turn the chilled water flow on and off as the chiller requires for operation and protection. This function is a requirement on the Stealth™ chiller.

Options

Applications Options

Ice Making

The ice making option provides special control logic to handle low temperature brine applications (less than 40°F [4.4°C] leaving evaporator temperature) for thermal storage applications.

Low Temperature Brine

The low temperature option provides special control logic to handle low temperature brine applications (less than 40°F [4.4°C] leaving evaporator temperature) including part load conditions.

Low Ambient Option

The low ambient options adds hardware and unit controls to allow start and operation down to ambient temperatures of 0°F (-17.7°C).

Extreme Low Ambient Option

The low ambient options adds hardware and unit controls to allow operation down to ambient temperatures of -20°F (-28.9°C).

High Ambient Option

High ambient option consists of special control logic, compressor motors, and variable speed drives to permit high ambient (up to 125°F [51°C]) operation. Low side ambient remains 32°F (0°C).

Wide Ambient Option

The low and wide ambient option combines the features of low and high ambient options for an ambient range of 0 to 125°F (-17.7 to 51°C).

Electrical Options

Circuit Breaker

A HACR rated molded case capacity circuit breaker (UL approved) is available. Circuit breaker can also be used to disconnect chiller from main power with a through-the-door handle. It comes pre-wired from factory with terminal block power connections. External operator handle is lockable.

Harmonic Attenuation

Harmonic attenuation to comply with IEEE 519 is available. It is important to recognize that IEEE 519 as a guideline relates to the entire system, not specifically to any one load or product. IEEE 519 establishes requirements at the point of common coupling (PCC) where the building connects to the utility system. The standard contains no specific requirements for the internal electrical loads. Even though Trane AFD-equipped chillers will attenuate their own harmonics, other nonlinear loads on the same system could still create harmonic problems. In buildings where harmonics might be a concern, Trane recommends conducting a power-distribution system analysis to determine if there is a need to further attenuate harmonics at the system level.

Control Options

BACnet Communications Interface

Allows the user to easily interface with BACnet[®] via a single twisted pair wiring to a factory installed and tested communication board.

LonTalk (LCI-C) Communications Interface

Provides the LonMark[®] chiller profile inputs/outputs for use with a generic building automation system via a single twisted pair wiring to a factory installed and tested communication board.

Options

ModBus Communications Interface

Allows easily interface with ModBus™ via a single twisted pair wiring to a factory installed and tested communication board.

Remote Input Options

Option permits remote chilled liquid setpoint, remote demand limit setpoint, or both by accepting a 4-20 mA or 2-10 Vdc analog signal.

Remote Output Options

Permits alarm relay outputs, ice making outputs, or both.

Tracer Communication Interface

Interface permits bi-directional communication to Tracer SC or ES system via BACnet interface.

Sound Options

InvisiSound Standard Unit

Each rotary screw compressor will have a muffler as standard and each condenser fan will be low noise as standard.

InvisiSound Superior Unit

In addition to the sound reducing features on the standard unit, Superior adds insulating sound material to the suction and discharge lines of each refrigerant circuit and reduces the maximum speed of the each condenser fan.

InvisiSound Ultimate Unit

In addition to the sound reducing features on the Superior, the Ultimate unit adds a flexible, metallic connection at the suction and discharge of each compressor, a pre-formed 'sound box' encapsulating each compressor and the ability for the user to set fan speed based on sound requirements. The fan speed can be set for sound reduction from 100% - 60% of maximum fan speed.

Other Options

Architectural Louvered Panels

Louvered panels cover the complete condensing coil and service area beneath the condenser.

Condenser Corrosion Protection

CompleteCoat™ is available on all size units for corrosion protection. Job site conditions should be considered to determine the need to order coating to inhibit coil corrosion and ensure extended equipment life. CompleteCoat option provides fully assembled coils with a flexible dip and bake epoxy coating.

Convenience Outlet

Option Provides a 15 amp, 115 volt (60 Hz) convenience outlet on the unit.

Flange Kit

Option provides a raised face flange kit that converts the grooved pipe evaporator water connections to flange connectors.

Insulation for High Humidity

The evaporator is covered with factory-installed 1.25 inch (31.8 mm) Armaflex II or equal (k=0.28) insulation.

Elastomeric Isolators

Isolators provide isolation between chiller and structure to help eliminate vibration transmission. Neoprene isolators are more effective and recommended over spring isolators and are required with the very low noise InvisiSound option.

Isopads - Seismically Rated

Isopads are designed and tested to control the motion of the chiller during a seismic event.

Seismically Rated Unit - IBC

Unit is built and certified for seismic applications in accordance with the following International Building Code (IBC) releases 2000, 2003, 2006, 2009 and 2012.

Seismically Rated Unit - OSHPD

Unit is built and certified for seismic applications in accordance with OSHPD.

Wind Load for Florida Hurricane

Unit is built and certified to meet the requirements of the 2010 Florida Building Code and ASCE 7-10 for 175 mph wind speed, Exposure 'C', Risk Category II. Available for non-rooftop mounted units only.



Trane optimizes the performance of homes and buildings around the world. A business of Ingersoll Rand, the leader in creating and sustaining safe, comfortable and energy efficient environments, Trane offers a broad portfolio of advanced controls and HVAC systems, comprehensive building services, and parts. For more information, visit www.Trane.com.

Trane has a policy of continuous product and product data improvement and reserves the right to change design and specifications without notice.